

SREB Readiness Courses
Transitioning to college and careers

College Readiness Mathematics

Unit 1 . Algebraic Expressions
Student Manual
Version 3

Name



Unit 1 . Algebraic Expressions

Table of Contents

Lesson 1.....	3
Lesson 2.....	6
Lesson 3.....	8
Lesson 4.....	10
Lesson 5.....	14
Lesson 6.....	19

Task #1: Bucky the Badger

Restate the Bucky the Badger problem in your own words:

Construct a viable argument for the following:

About how many total push-ups do you think Bucky did during the game?

Write down a number that you know is too high.

Write down a number that you know is too low.

What further information would you need to know in order to determine the exact number of total push-ups Bucky did in the course of the game?

If you're Bucky, would you rather your team score their field goals at the start of the game or the end?

What are some numbers of pushups that Bucky will never do in any game?

Task #2: Reasoning about Multiplication and Division and Place Value

Use the fact that $13 \times 17 = 221$ to find the following:

a. 13×1.7

b. 130×17

c. 13×1700

d. 1.3×1.7

e. $2210 \div 13$

f. $22100 \div 17$

g. $221 \div 1.3$

(Source: Illustrative Mathematics)

Task #3: Felicia's Drive

As Felicia gets on the freeway to drive to her cousin’s house, she notices that she is a little low on gas. There is a gas station at the exit she normally takes, and she wonders if she will have to get gas before then. She normally sets her cruise control at the speed limit of 70mph and the freeway portion of the drive takes about an hour and 15 minutes. Her car gets about 30 miles per gallon on the freeway, and gas costs \$3.50 per gallon. (Source: Illustrative Mathematics)

- a. Describe an estimate that Felicia might do in her head while driving to decide how many gallons of gas she needs to make it to the gas station at the other end.

- b. Assuming she makes it, how much does Felicia spend per mile on the freeway?

Numbers and Operations

Magic Math: Number Guess



Instructions

Original Number	

Numbers and Operations

Magic Math: Birthday Trick

Do you believe that I can figure out your birthday by using simple math?

Get a calculator and ask your classmate to try the following. Your classmate must press equal (or enter) between every step.

- a) Enter the month of his/her birth into the calculator. (Ex: enter 5 for May)
- b) Multiply that number by 7.
- c) Subtract 1 from that result.
- d) Multiply that result by 13.
- e) Add the day of birth. (Ex: For June 14th add 14)
- f) Add 3.
- g) Multiply by 11.
- h) Subtract the month of birth.
- i) Subtract the day of birth.
- j) Divide by 10.
- k) Add 11.
- l) Divide by 100.

Task #4: Miles to Kilometers

The students in Mr. Sanchez's class are converting distances measured in miles to kilometers. To estimate the number of kilometers, Abby takes the number of miles, doubles it, then subtracts 20% of the result. Renato first divides the number of miles by 5 and then multiplies the result by 8.

- a. Write an algebraic expression for each method.

- b. Use your answer to part (a) to decide if the two methods give the same answer.

(Source: Illustrative Mathematics)

Independent Practice:

School Lunches & Movie Tickets

Find the cost of school lunches (adult and student) for three different area schools. Then create a table of values. Also find the number of students and teachers at each school.

Write an expression based on the table for each of the following:

Schools	Student	Adult
A		
B		
C		

- A. Cost of feeding 30 students and 5 adults
- B. Cost of feeding 43 adults and 75 students
- C. Cost of feeding each of the school’s students and teachers.

Find movie tickets prices at five different cities around the country. Include adult, children, matinee and regular shows.

City	Adult matinee	Adult regular	Child matinee	Child regular
A				
B				
C				
D				
E				

- A. You have \$100. In which city can you take the most adults and children to the matinee, if for every two children there is an adult?

- B. What is the cost of four children and three adults for a matinee in each of the five cities?

- C. Which city has the best deal for a family of five to attend the movies? Decide whether it is a matinee or regular show.

Task 5: Swimming Pool

You want to build a square swimming pool in your backyard. Let s denote the length of each side of the swimming pool (measured in feet). You plan to surround the pool by square border tiles, each of which is 1 foot by 1 foot (see figure).

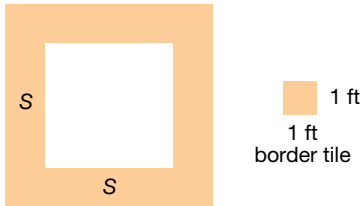

A teacher asks her students to find an expression for the number of tiles needed to surround such a square pool, and sees the following responses from her students:

$4(s+1)$

s^2

$4s+4$

$2s+2(s+2)$

$4s$

Is each mathematical model correct or incorrect? How do you know?

$4(s+1)$ _____

s^2 _____

$4s+4$ _____

$2s+2(s+2)$ _____

$4s$ _____

Task #6: Smartphones

Suppose p and q represent the price (in dollars) of a 64GB and a 32GB smartphone, respectively, where $p > q$. Interpret each of the expressions in terms of money and smartphones. Then, if possible, determine which of the expressions in each pair is larger.

$p+q$ and $2q$

$p+0.08p$ and $q+0.08q$

$600-p$ and $600-q$

Task #7: University Population

Let x and y denote the number male and female students, respectively, at a university. where $x < y$. If possible, determine which of the expressions in each pair is larger? Interpret each of the expressions in terms of populations.

$x+y$ and $2y$

$\frac{x}{x+y}$ and $\frac{y}{x+y}$

$\frac{x-y}{2}$ and $\frac{x}{x+y}$

Independent Practice

For each pair of expressions below, without substituting in specific values, determine which of the expressions in the given pairs is larger. Explain your reasoning in a sentence or two.

$$5+t^2 \text{ and } 3-t^2$$

$$\frac{15}{x^2+6} \text{ and } \frac{15}{x^2+7}$$

$$(s^2+2)(s^2+1) \text{ and } (s^2+4)(s^2+3)$$

$$\frac{8}{k^2+2} \text{ and } k^2+2$$

Task #8: Sidewalk Patterns

Sidewalk Patterns

In Prague some sidewalks are made of small square blocks of stone.

The blocks are in different shades to make patterns that are in various sizes.

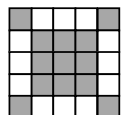

Pattern #1

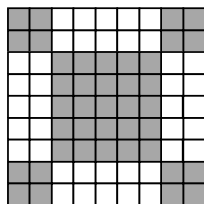

Pattern #2

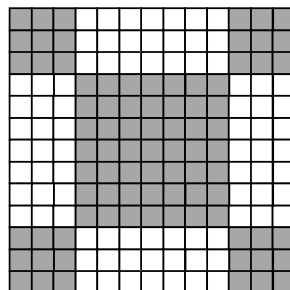

Pattern #3

Draw the next pattern in this series.

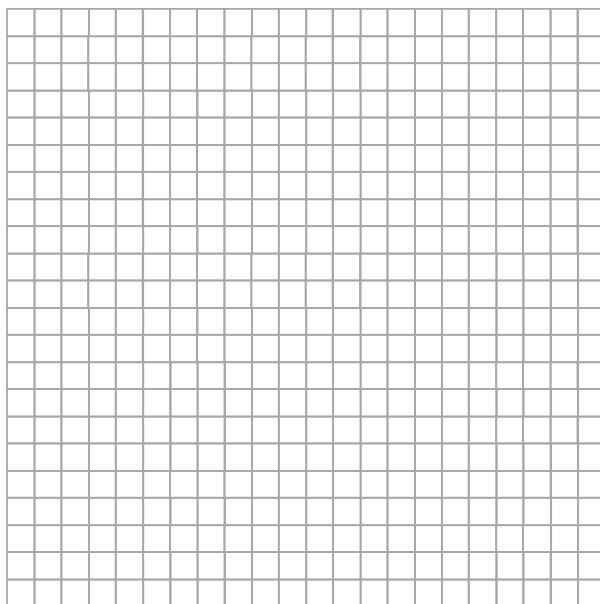

Pattern #4

1. Complete the table below

Pattern number, n	1	2	3	4
Number of white blocks	12	40		
Number of gray blocks	13			
Total number of blocks	25			

2. What do you notice about the number of white blocks and the number of gray blocks?

3. The total number of blocks can be found by squaring the number of blocks along one side of the pattern.

a. Fill in the blank spaces in this list.

$25 = 5^2$ $81 = \underline{\hspace{2cm}}$ $169 = \underline{\hspace{2cm}}$ $289 = 17^2$

b. How many blocks will pattern #5 need? _____

c. How many blocks will pattern # n need? _____

4. a. If you know the total number of blocks in a pattern you can work out the number of white blocks in it. Explain how you can do this.

b. Pattern # 6 has a total of 625 blocks.
How many white blocks are needed for pattern #6? _____
Show how you figured this out.

Task #9: Expression Pairs: Equivalent or Not?

$a+(3-b)$ and $(a+3)-b$

$2+\frac{k}{5}$ and $10+k$

$(a-b)^2$ and a^2-b^2

$3(z+w)$ and $3z+3w$

$-a+2$ and $-(a+2)$

$\frac{1}{x+y}$ and $\frac{1}{x} + \frac{1}{y}$

x^2+4x^2 and $5x^2$

$\sqrt{x^2+y^2}$ and $x+y$

$bc-cd$ and $c(b-d)$

$(2x)^2$ and $4x^2$

$2x+4$ and $x+2$

Task #10: Kitchen Floor Tiles

Fred has some colored kitchen floor tiles and wants to choose a pattern to make a border around white tiles. He generates patterns by starting with a row of four white tiles. He surrounds these four tiles with a border of colored tiles (Border 1). The design continues as shown below:

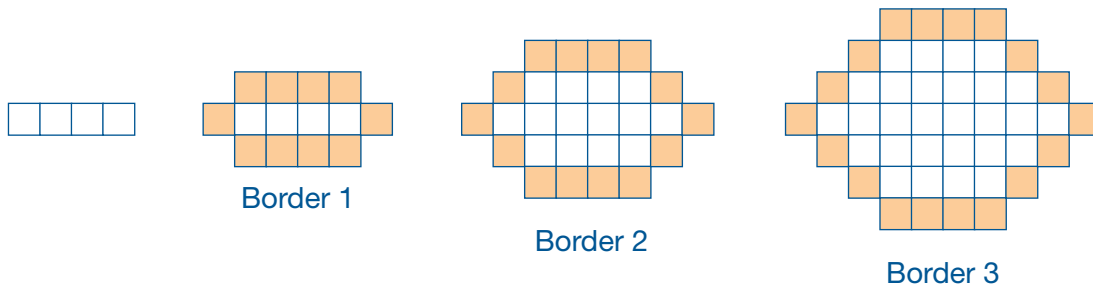

Fred writes the expression $4(b-1) + 10$ for the number of tiles in each border, where b is the border number, $b \geq 1$.

- Explain why Fred’s expression is correct.

- Emma wants to start with five tiles in a row. She reasons, “Fred started with four tiles and his expression was $4(b-1) + 10$. So if I start with five tiles, the expression will be $5(b-1) + 10$. Is Emma’s statement correct? Explain your reasoning.

- If Emma starts with a row of n tiles, what should the expression be?

Independent Practice

On the figure below, indicate intervals of length:

- $x+1$
- $3x+1$
- $3(x+1)$



What do your answers tell you about whether $3x+1$ and $3(x+1)$ are equivalent?

Task #11: Distributive Property Using Area

Distributive Property Using Area

NAME _____

Write the expression that represents the area of each rectangle.

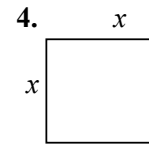
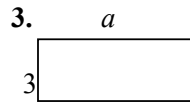
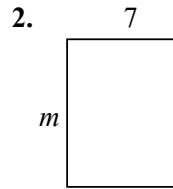
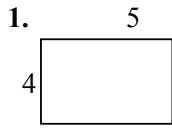

Find the area of each box in the pair.

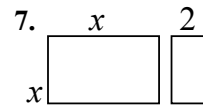
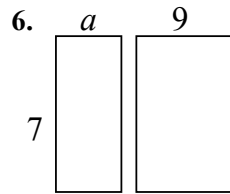
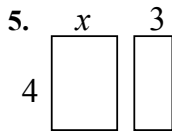

Write the expression that represents the total length of each segment.

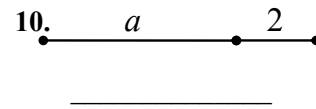
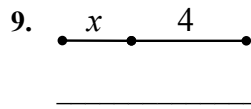
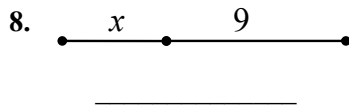

Write the area of each rectangle as the product of *length* \times *width* and also as a sum of the areas of each box.

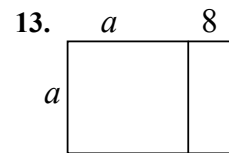
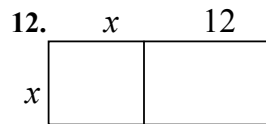
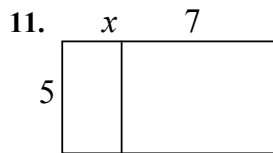

AREA AS PRODUCT	AREA AS SUM
$5(x+7)$	$5x+35$

AREA AS PRODUCT	AREA AS SUM

AREA AS PRODUCT	AREA AS SUM

This process of writing these products as a sum uses the **distributive property**.

Use the distributive property to re-write each expression as a sum. You may want to draw a rectangle on a separate page to follow the technique above.

- 14. $4(x+7) =$ _____
- 16. $-2(x+4) =$ _____
- 18. $a(a-1) =$ _____
- 20. $-4(a-4) =$ _____

- 15. $7(x-3) =$ _____
- 17. $x(x+9) =$ _____
- 19. $3m(m+2) =$ _____
- 21. $a(a-12) =$ _____

Task #12: Factoring a Common Factor Using Area

Factoring a Common Factor Using Area

NAME _____

Fill in the missing information for each: dimensions, area as product, and area as sum

<p>1.</p> <table border="1" style="margin-left: 40px; border-collapse: collapse;"> <tr> <td style="width: 50px; text-align: center;">x</td> <td style="width: 50px; text-align: center;">6</td> </tr> <tr> <td style="width: 50px; text-align: center;">2</td> <td style="width: 50px; text-align: center;">2</td> </tr> </table> <p>_____</p> <p>_____</p>	x	6	2	2	<p>2.</p> <table border="1" style="margin-left: 40px; border-collapse: collapse;"> <tr> <td style="width: 50px; text-align: center;"><input type="text"/></td> <td style="width: 50px; text-align: center;"><input type="text"/></td> </tr> <tr> <td style="width: 50px; text-align: center;">5</td> <td style="width: 50px; text-align: center;">$5x$</td> </tr> </table> <p>_____</p> <p>_____</p>	<input type="text"/>	<input type="text"/>	5	$5x$	<p>3.</p> <table border="1" style="margin-left: 40px; border-collapse: collapse;"> <tr> <td style="width: 50px; text-align: center;"><input type="text"/></td> <td style="width: 50px; text-align: center;">8</td> </tr> <tr> <td style="width: 50px; text-align: center;"><input type="text"/></td> <td style="width: 50px; text-align: center;">$6x$</td> </tr> </table> <p>_____</p> <p>_____</p>	<input type="text"/>	8	<input type="text"/>	$6x$	<p>4.</p> <table border="1" style="margin-left: 40px; border-collapse: collapse;"> <tr> <td style="width: 50px; text-align: center;">x</td> <td style="width: 50px; text-align: center;"><input type="text"/></td> </tr> <tr> <td style="width: 50px; text-align: center;"><input type="text"/></td> <td style="width: 50px; text-align: center;">$10x$</td> </tr> </table> <p>_____</p> <p>_____</p>	x	<input type="text"/>	<input type="text"/>	$10x$
x	6																		
2	2																		
<input type="text"/>	<input type="text"/>																		
5	$5x$																		
<input type="text"/>	8																		
<input type="text"/>	$6x$																		
x	<input type="text"/>																		
<input type="text"/>	$10x$																		

Fill in the missing dimensions from the expression given.

<p>5. $5x + 35 = 5(\text{_____})$</p> <table border="1" style="margin-left: 40px; border-collapse: collapse;"> <tr> <td style="width: 50px; text-align: center;"><input type="text"/></td> <td style="width: 50px; text-align: center;"><input type="text"/></td> </tr> <tr> <td style="width: 50px; text-align: center;"><input type="text"/></td> <td style="width: 50px; text-align: center;"><input type="text"/></td> </tr> </table>	<input type="text"/>	<input type="text"/>	<input type="text"/>	<input type="text"/>	<p>6. $2x + 12 = 2(\text{_____})$</p> <table border="1" style="margin-left: 40px; border-collapse: collapse;"> <tr> <td style="width: 50px; text-align: center;"><input type="text"/></td> <td style="width: 50px; text-align: center;"><input type="text"/></td> </tr> <tr> <td style="width: 50px; text-align: center;"><input type="text"/></td> <td style="width: 50px; text-align: center;"><input type="text"/></td> </tr> </table>	<input type="text"/>	<input type="text"/>	<input type="text"/>	<input type="text"/>	<p>7. $3x - 21 = \text{_____}(\text{_____})$</p> <table border="1" style="margin-left: 40px; border-collapse: collapse;"> <tr> <td style="width: 50px; text-align: center;"><input type="text"/></td> <td style="width: 50px; text-align: center;"><input type="text"/></td> </tr> <tr> <td style="width: 50px; text-align: center;"><input type="text"/></td> <td style="width: 50px; text-align: center;"><input type="text"/></td> </tr> </table>	<input type="text"/>	<input type="text"/>	<input type="text"/>	<input type="text"/>
<input type="text"/>	<input type="text"/>													
<input type="text"/>	<input type="text"/>													
<input type="text"/>	<input type="text"/>													
<input type="text"/>	<input type="text"/>													
<input type="text"/>	<input type="text"/>													
<input type="text"/>	<input type="text"/>													
<p>8. $7x - 21 = \text{_____}(\text{_____})$</p> <table border="1" style="margin-left: 40px; border-collapse: collapse;"> <tr> <td style="width: 50px; text-align: center;"><input type="text"/></td> <td style="width: 50px; text-align: center;"><input type="text"/></td> </tr> <tr> <td style="width: 50px; text-align: center;"><input type="text"/></td> <td style="width: 50px; text-align: center;"><input type="text"/></td> </tr> </table>	<input type="text"/>	<input type="text"/>	<input type="text"/>	<input type="text"/>	<p>9. $-3x - 15 = -3(\text{_____})$</p> <table border="1" style="margin-left: 40px; border-collapse: collapse;"> <tr> <td style="width: 50px; text-align: center;"><input type="text"/></td> <td style="width: 50px; text-align: center;"><input type="text"/></td> </tr> <tr> <td style="width: 50px; text-align: center;"><input type="text"/></td> <td style="width: 50px; text-align: center;"><input type="text"/></td> </tr> </table>	<input type="text"/>	<input type="text"/>	<input type="text"/>	<input type="text"/>	<p>10. $-5x + 45 = \text{_____}(\text{_____})$</p> <table border="1" style="margin-left: 40px; border-collapse: collapse;"> <tr> <td style="width: 50px; text-align: center;"><input type="text"/></td> <td style="width: 50px; text-align: center;"><input type="text"/></td> </tr> <tr> <td style="width: 50px; text-align: center;"><input type="text"/></td> <td style="width: 50px; text-align: center;"><input type="text"/></td> </tr> </table>	<input type="text"/>	<input type="text"/>	<input type="text"/>	<input type="text"/>
<input type="text"/>	<input type="text"/>													
<input type="text"/>	<input type="text"/>													
<input type="text"/>	<input type="text"/>													
<input type="text"/>	<input type="text"/>													
<input type="text"/>	<input type="text"/>													
<input type="text"/>	<input type="text"/>													

This process of writing a sum or difference as the product of factors is called **factoring**.

Factor these:

- | | |
|------------------------------|-------------------------------|
| 11. $4x - 16 = \text{_____}$ | 12. $-7x - 35 = \text{_____}$ |
| 13. $9x - 81 = \text{_____}$ | 14. $4x + 18 = \text{_____}$ |

Task #13: Distributive Property

Are the expressions equivalent? Sketch and simplify to prove. If the two expressions are not equal write the correct equivalence.

1. $3(x+3)$ and $3x+6$



2. $6(y+1)$ and $6y+6$

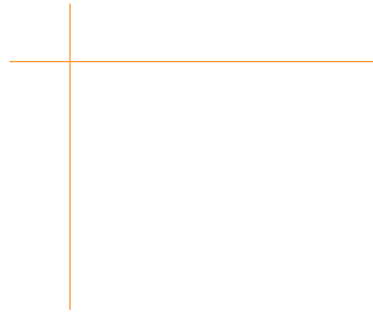

3. $x(x+4)$ and x^2+4



4. $y(x+2)$ and $xy+2y$



5. $x(x+y+2)$ and $x^2+xy+2x$



6. $2x(x+3)$ and $2x^2+6x$

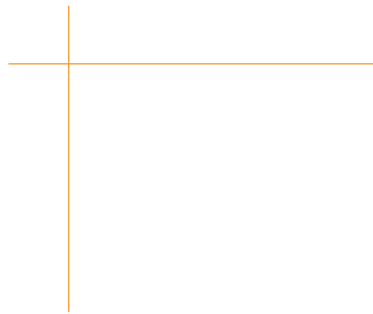

Distribute the following. Use a sketch or just distribute if you can.

1. $3(x+2)$

2. $4(y-1)$

3. $x(x+6)$

4. $x(y+4)$

5. $3x(x+y-1)$

Algebraic Expressions

Additional Problem Sets

Note for the Teacher: *The problem sets below are provided to you as supplemental material. You may choose to use these problems for extra practice, assessment, re-teach and/or enrichment opportunities.*

1.
 - a. Sandra has 6 grandchildren, and she gave each of them \$24.50. How much money did she give to her grandchildren altogether?
 - b. Nita bought some games for her grandchildren for \$42.50 each. If she spent a total of \$340, how many games did Nita buy?
 - c. Helen gave each of her 7 grandchildren an equal amount of money. If she gave a total of \$227.50, how much did each grandchild get?

2. Sophia's dad paid \$43.25 for 12.5 gallons of gas. What is the cost of one gallon of gas?

3. Hallie is in 6th grade and she can buy movie tickets for \$8.25. Hallie's father was in 6th grade in 1987 when movie tickets cost \$3.75.
 - a. When he turned 12, Hallie's father was given \$20.00 so he could take some friends to the movies. How many movie tickets could he buy with this money?
 - b. How many movie tickets can Hallie buy for \$20.00?
 - c. On Hallie's 12th birthday, her father said,
When I turned 12, my dad gave me \$20 so I could go with three of my friends to the movies and buy a large popcorn. I'm going to give you some money so you can take three of your friends to the movies and buy a large popcorn.
How much money do you think her father should give her?

4. Nina was finding multiples of 6. She said,
18 and 42 are both multiples of 6, and when I add them, I also get a multiple of 6:
 $18+42=60$.
Explain to Nina why adding two multiples of 6 will always result in another multiple of 6.

5. On the same winter morning, the temperature is -28° in Anchorage, Alaska and 65° in Miami, Florida. How many degrees warmer was it in Miami than in Anchorage on that morning?

6. Denver, Colorado is called “The Mile High City” because its elevation is 5280 feet above sea level. Someone tells you that the elevation of Death Valley, California is -282 feet.
 - a. Is Death Valley located above or below sea level? Explain.
 - b. How many feet higher is Denver than Death Valley?
 - c. What would your elevation be if you were standing near the ocean?

7. Ocean water freezes at about $-2\frac{1}{2}^{\circ}\text{C}$. Fresh water freezes at 0°C . Antifreeze, a liquid used to cool most car engines, freezes at -64°C . Imagine that the temperature is exactly at the freezing point for ocean water. How many degrees must the temperature drop for the antifreeze to turn to ice?

8. Rosa ran $\frac{1}{3}$ of the way from her home to school. She ran $\frac{1}{4}$ mile. How far is it between her home and school?

9. You are stuck in a big traffic jam on the freeway and you are wondering how long it will take to get to the next exit, that is $1\frac{1}{2}$ miles away. You are timing your progress and find that you can travel $\frac{2}{3}$ of a mile in one hour. If you continue to make progress at this rate, how long will it be until you reach the exit? Solve the problem with a diagram and explain your answer.

10. It requires $\frac{1}{4}$ of a credit to play a video game for one minute.
 - a. Emma has $\frac{7}{8}$ credits. Can she play for more or less than one minute? Explain how you know.
 - b. How long can Emma play the video game with her $\frac{7}{8}$ credits?

11. Three math classes at Sunview High School collected the most box tops for a school fundraiser, and so they won a \$600 prize to share among them. Mr. Aceves’ class collected 3,760 box tops, Mrs. Baca’s class collected 2,301, and Mr. Canyon’s class collected 1,855. How should they divide the money so that each class gets the same fraction of the prize money as the fraction of the box tops that they collected?

12. After opening an ancient bottle you find on the beach, a Djinni appears. In payment for his freedom, he gives you a choice of either 50,000 gold coins or one magical gold coin. The magic coin will turn into two gold coins on the first day. The two coins will turn into four coins total at the end of two days. By the end of the third day there will be eight gold coins total. The Djinni explains that the magic coins will continue this pattern of doubling each day for one moon cycle, 28 days. Which prize do you choose?

When you have made your choice, answer these questions:

- The number of coins on the third day will be $2 \times 2 \times 2$. Can you write another expression using exponents for the number of coins there will be on the third day?
- Write an expression for the number of coins there will be on the 28th day. Is this more or less than a million coins?

13. Evaluate the following numerical expressions.

- $2(5+(3)(2)+4)$
- $2((5+3)(2+4))$
- $2(5+3(2+4))$

Can the parentheses in any of these expressions be removed without changing the value the expression?

14. Some of the students at Kahlo High School like to ride their bikes to and from school. They always ride unless it rains. Let d be the distance in miles from a student's home to the school. Write two different expressions that represent how far a student travels by bike in a four-week period if there is one rainy day each week.

15. Which of the following expressions are equivalent? Why? If an expression has no match, write 2 equivalent expressions to match it.

- $2(x+4)$
- $8+2x$
- $2x+4$
- $3(x+4)-(4+x)$
- $x+4$

SREB Readiness Courses
Transitioning to college and careers

College Readiness Mathematics

Unit 2 . Equations
Student Manual
Version 3

Name



Unit 2 . Equations

Table of Contents

Lesson 1.....	3
Lesson 2.....	7
Lesson 4.....	10
Lesson 5.....	16

Task #1: New Shoes

You want to buy a new pair of shoes. While looking around at different shoes and styles online, you see a coupon for \$10 off a pair of shoes at a local retailer in town. When you arrive at the store, you see they have sale, 15% off any pair of shoes in stock, but you are not allowed to apply any additional discounts. You do the math to decide whether the coupon or the 15% discount will save you the most money, and you find out the discounted price is the same no matter whether you use the coupon or receive 15% off from the sale. How much did the pair of shoes cost?

Task #2: Equation Problems

1. Three girls downloaded a total of 36 songs on their iPods. Jane downloaded twice as many as Inez and since Tracy wanted to have the most, she downloaded one more than Jane did. How many songs did each girl download?

2. A checking account is set up with an initial balance of \$4,800, and \$300 is removed from the account each month for rent (no other transactions occur on the account). How many months will it take for the account balance to reach \$1,500?

3. Peyton is three years younger than Justin. Matt is four times as old as Peyton. If you add together the ages of Justin, Peyton and Matt, the total comes to 39 years. How old are Justin, Peyton, and Matt?

Task #3: Gasoline Cost

You have \$40 to spend on n gallons of gas that costs \$3.25 per gallon. Determine whether each of the following is an expression or an equation. Using the structure, give an interpretation of the practical meaning of each.

1. $3.25n$

2. $3.25n = 26$

3. $40 - 3.25n$

4. $40 - 3.25n = 1.00$

Task #4: Equations and Solutions

For each of the equations below, determine whether the given value is a solution or not.

1. $x + 2 = x^2 + 4$ at $x = 2$

2. $p + 2 = p^2 - 4$ at $p = -2$

3. $\frac{a-5}{a+5} = 1$ at $a = 0$

4. $\frac{5-a}{5+a} = -1$ at $a = 0$

5. $3(x-8) = 3x-8$ at $x = 0$

6. Which, out of the numbers 0, 1, -1, 2, -2, is/are solution(s) to the equation $4x^2 - 4x - 5 = 2x(x+3) - 1$?

Task #5: Same Solution?

Which of the following equations have the same solution? Give reasons for your answer that do not depend on solving the equations.

I. $x + 3 = 5x - 4$

II. $x - 3 = 5x + 4$

III. $2x + 8 = 5x - 3$

IV. $10x + 6 = 2x - 8$

V. $10x - 8 = 2x + 6$

VI. $0.3 + \frac{x}{10} = \frac{1}{2}x - 0.4$

(Source: Illustrative Mathematics)

Task #6: Equivalent or Not?

For each pair of equations, determine whether the second equation is the result of a valid operation on the first. If so, what is the operation?

1. $7 + 5x = 3 - 2x$ and $7 + 7x = 3$

2. $3(x - 4) = 15$ and $x - 4 = 15$

3. $x^2 = 6x$ and $x = 6$

4. $\frac{1}{(x - 5)} = 10$ and $1 = 10(x - 5)$

Task #7: Study Questions

You and a friend are getting ready to study for an assessment on expressions and equations. Knowing that your friend is still getting expressions and equations mixed up and doesn't always know how to tell if two expressions or two equations are equivalent, your job is to create a set of problems (and solutions) to help your friend study. Create a minimum of six problems that will address your friend's misconceptions and include the solutions for her/him to study. Make sure your reasoning is clearly articulated in the solutions.

Task #8: How Does the Solution Change?

In the equations (a)-(d), the solution x to the equation depends on the constant a . Assuming a is positive, what is the effect of increasing a on the solution? Does it increase, decrease or remain unchanged? **Give a reason for your answer that can be understood without solving the equation.**

a) $x - a = 0$

b) $ax = 1$

c) $ax = a$

d) $\frac{x}{a} = 1$

(Source: Illustrative Mathematics)

Task #9: Headphones

A store sells two brands of headphones: high definition (HD) and basic. It buys x HD headphones at z dollars each, and y basic headphones at w dollars each.

In a-c, write an equation whose solution is the given quantity. Do not solve the equations, just set them up.

a) The number of basic headphones the store can purchase if it spends a total of \$10,000 on headphones and buys 110 HD headphones for \$70 each.

b) The price the store pays for HD headphones if it spends a total of \$2,000 on headphones and buys 55 basic headphones for \$20 each.

c) The price the store pays for HD headphones if it spends a total of \$800 on headphones and buys eight basic headphones for \$80 each.

Task #10: Buying a Car

Suppose a friend tells you she paid a total of \$16,368 for a car, and you'd like to know the car's list price (the price before taxes) so that you can compare prices at various dealers. Find the list price of the car if your friend bought the car in:

a) Arizona, where the sales tax is 6.6%.

b) New York, where the sales tax is 8.25%.

c) A state where the sales tax is r .

d) Solve for r in your answer to (c) above.

(Source: Illustrative Mathematics)

Task #11: Literal Equations

a) $A = hw$, solve for h .

b) $P = 2w + 2h$, solve for w .

c) $V = \pi r^2 h$, solve for h (or r if you have spent time with square roots).

d) $h = v_0 t + \frac{1}{2} a t^2$, solve for a .

e) $\frac{2xy - 7}{3xy + 8} = 1$, solve for y .

Task #12: Equations and Formulas

Use inverse operations to solve the equations for the unknown variable or for the designated variable if there is more than one. If there is more than one operation to “undo,” be sure to think carefully about the order in which you do them. For equations with multiple variables, it may help to first solve a version of the problem with numerical values substituted in.

a. $5 = a - 3$

b. $A - B = C$ (solve for A)

c. $6 = -2x$

d. $IR = V$ (solve for R)

e. $\frac{x}{5} = 3$

f. $W = \frac{A}{L}$ (solve for A)

g. $7x + 3 = 10$

h. $ax + c = R$ (solve for x)

i. $13 = 15 - 4x$

j. $2h = w - 3p$ (solve for p)

k. $F = \frac{GMm}{r^2}$ (solve for G)

(Source: Illustrative Mathematics)

Task 13: Evan and Megan

- Evan will be given a number between zero and 999.
- Evan multiplies the number by four and gives the result to Megan.
- Whenever Megan gets a number, she subtracts it from 2,000 and passes the result back to Evan.
- Evan multiplies that by four and passes the number back to Megan, etc.
- The winner is the last person who produces a number less than 1,000.

Break into pairs and record a couple of iterations of the game on a similar table:

Name	1	2	3	4
Evan	200	400		
Megan	800	1600		

In the example above, Megan wins in round two since Evan produced a number greater than 1,000.

Name	1	2	3	4
Evan	300			
Megan	1200			

In the example above, Megan wins in round one since Evan produced a number greater than 1,000. Thus we see in this case, large values cause Evan to lose whereas in the previous game, when Evan received a large number initially, he won.

How can this situation be represented as an inequality? Work in your groups to set up and solve an inequality.

Task #14: Inequality Behavior

In each case, describe what operations occurred to move from the direct, previous line. Using what you know about the structure of our number system, make a decision for the inequality symbol.

Beginning Numbers	Description of operation	Inequality
2 5	Begin	$2 < 5$
4 10	Multiplied by 2	$4 < 10$
-1 5		$-1 > 5$
5 -25		$5 < -25$
15 -15		$15 < -15$
3 -3		$3 < -3$
-3 3		$-3 < 3$

What operations appear to be “flipping” the sign?

What is true about the negative number system?

Does adding and subtracting a negative number ALWAYS/SOMETIMES/NEVER produce an opposite number? Explain.

Does multiplying or dividing by a negative number ALWAYS/SOMETIMES/NEVER produce an opposite number? Explain.

Task #15: Fishing Adventures

Fishing Adventures rents small fishing boats to tourists for day-long fishing trips. Each boat can only carry 1,200 pounds (lbs) of people and gear for safety reasons. Assume the average weight of a person is 150 pounds. Each group will require 200 pounds of gear for the boat plus 10 pounds of gear for each person.

- a) Create an inequality describing the restrictions on the number of people possible in a rented boat. Graph the solution set.

- b) Several groups of people wish to rent a boat. Group one has four people. Group two has five people. Group three has eight people. Which of the groups, if any, can safely rent a boat? What is the maximum number of people that may rent a boat?

(Source: Illustrative Mathematics)

Task #16: Sports Equipment Set

Jonathan wants to save up enough money so that he can buy a new sports equipment set that includes a football, baseball, soccer ball, and basketball. This complete boxed set costs \$50. Jonathan has \$15 he saved from his birthday. In order to make more money, he plans to wash neighbors' windows. He plans to charge \$3 for each window he washes, and any extra money he makes beyond \$50 he can use to buy the additional accessories that go with the sports box set.

Write and solve an inequality that represents the number of windows Jonathan can wash in order to save at least the minimum amount he needs to buy the boxed set. Graph the solutions on the number line. What is a realistic number of windows for Jonathan to wash? How would that be reflected in the graph?

(Source: Illustrative Mathematics)

Task #17: Basketball

Chase and his brother like to play basketball. About a month ago they decided to keep track of how many games they have each won. As of today, Chase has won 18 out of the 30 games against his brother.

- a. How many games would Chase have to win in a row in order to have a 75% winning record?

- b. How many games would Chase have to win in a row in order to have a 90% winning record?

- c. Is Chase able to reach a 100% winning record? Explain why or why not.

- d. Suppose that after reaching a winning record of 90% in part (b), Chase had a losing streak. How many games in a row would Chase have to lose in order to drop down to a winning record below 55%?

(Source: Illustrative Mathematics)

Task #18: Solving Inequalities

Solve each of the following. Explain each step in your work, and check your answers.

1. Jane plans to purchase three pairs of slacks all costing the same amount, and a blouse that is \$4 cheaper than one of the pairs of slacks. She has \$75 to spend but wants to have at least \$3 left. What is the price range for the slacks?

2. $(-3x + 7) - 4(2x - 6) - 12 \geq 7$

3. $-3(5x - 3) < 4(x + 3) - 12$

(Source: Illustrative Mathematics)

SREB Readiness Courses
Transitioning to college and careers

Math Ready

Unit 3 . Measurement
and Proportional Reasoning
Student Manual
Version 3

Name



Unit 3 . Measurement and Proportional Reasoning

Table of Contents

Lesson 1.....	3
Lesson 2.....	5
Lesson 4.....	10
Lesson 5.....	16
Lesson 7.....	24
Lesson 8.....	27

Task #1: Heart Rate Closing Activity

1. Find your pulse and count how many times it beats in 15 seconds.

2. Run (in place if necessary) for 2 minutes. Now take your pulse for 15 seconds. Record your result.

3. At this rate, how long would it take for your heart to beat 700,000 times? Express your answer in days. Now express your answer in days, hours, minutes, and seconds. (example: 2 days, 4 hours, 21 minutes, 15 seconds)

4. You are training for a 5K race. This morning you ran 8 miles in 1 hour. If you run the race at this speed, how many minutes will it take you to run a 5K race?

Task #2: Heart Rate Extension Activity

Find a person 30 years old or older and record his/her approximate age.

a. Measure his/her pulse for 15 seconds. What would it be in 1 minute?

b. Have the person run in place for 2 minutes. Now take his/her pulse again for 15 seconds. What would it be in 1 minute?

c. How many times would that person's heart beat if he/she ran a 5K race? (If you don't have a rate at which this person runs, assume the person can average 6 mph during the race.)

Research to find a table of values for healthy heart rates to find out if your heart rate and the other person's heart rate are healthy.

Task #3: Fuel for Thought – Student Activity Sheet Part 1

A Fuel-ish Question

1. Which of the following would save more fuel?
 - a. Replacing a compact car that gets 34 miles per gallon (mpg) with a hybrid that gets 54 mpg.
 - b. Replacing a sport utility vehicle (SUV) that gets 18 mpg with a sedan that gets 28 mpg.
 - c. Both changes would save the same amount of fuel.

2. Explain your reasoning for your choice.

Task #4: Fuel for Thought – Student Activity Sheet Part 2

Extending the Discussion – MPG vs. Fuel Consumption

1. Complete the following chart comparing mpg and fuel consumption.

MPG	Fuel consumed to travel 100 miles

2. Use your values to sketch a graph.

Task #5: Map Activity Sheet

You are planning a trip from _____ to _____ on Highway _____.
(city name) *(city name)* *(Route)*

You want to determine the distance between these cities by using the map. On the map, locate the legend showing the scale of miles and answer the following questions.

1. How many miles are represented by 1 inch on the map?

2. How many inches represent 5 miles? How did you get your answer?

3. How many inches are there between the two cities listed above?

4. How many miles are there between these two cities?

Task #6: Unit Conversion Problems

Medicine: A doctor orders 250 mg of Rocephin to be taken by a 19.8 lb infant every 8 hours. The medication label shows that 75-150 mg/kg per day is the appropriate dosage range. Is this doctor's order within the desired range?

Agriculture: You own an empty one acre lot. (640 acres = 1 mi²; 1 mi = 5,280 ft)

a. If 1 inch of rain fell over your one acre lot, how many cubic inches of water fell on your lot?

b. How many cubic feet of water fell on your lot?

c. If 1 cubic foot of water weighs about 62 pounds, what is the weight of the water that fell on your lot?

d. If the weight of 1 gallon of water is approximately 8.3 pounds, how many gallons of water fell on your lot?

Astronomy: Light travels 186,282 miles per second.

a. How many miles will light travel in one year? (Use 365 days in a year) This unit of distance is called a light-year.

b. Capella is the 6th brightest star in the sky and is 41 light-years from earth. How many miles will light from Capella travel on its way to earth?

c. Neptune is 2,798,842,000 miles from the sun. How many hours does it take light to travel from the sun to Neptune?

Task #7: Scaling Activity

Look at the two pictures below. The first picture is the Washington Monument in Washington DC. The second is of the Eiffel Tower in France.

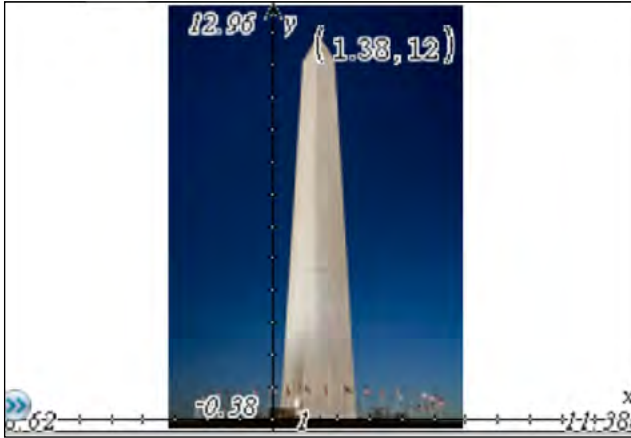

Washington Monument

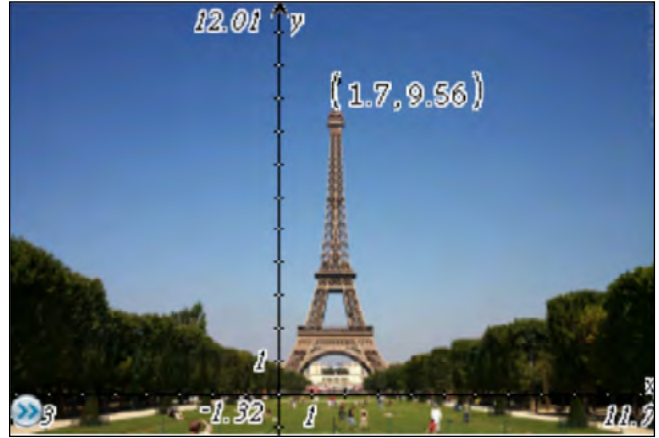

Eiffel Tower

If you just look at the diagrams which appears to be the taller object?

The scale for the Washington Monument is 1 unit \approx 46.25 feet.

The scale for the Eiffel Tower is 1 unit \approx 33.9 meters.

Round your answers to the nearest whole number.

A. Find the height of the Washington Monument.

B. Find the height of the Eiffel Tower.

Now let's think about the original question posed, which of the monuments is actually the taller? What will we have to do with our answers from A and B above to find the solution? Show and explain your work for this problem below.

Task #8: Scale Drawing Class Project

Goal: To use scale drawing to recreate a card.

Project:

1. Find two identical greeting cards or make a copy of the original card.
2. Draw a 1 cm grid on the back of the original card.
3. Number each of the squares – this will be used to assemble the final project.
4. Cut the card into squares following the grid lines.
5. Place the cut squares into a container and chose one square, record which square you selected.
6. From the teacher, receive an 8" x 8" square of white paper.
7. Reproduce and color the square that you drew from the container onto the 8" x 8" sheet of paper using scale drawing.
8. Display the final drawing by placing the squares on a wall along with the original card.

Questions:

1. Look at the finished product and evaluate the display. Did the lines match up? Which part looks the best? Which piece would have been the easiest to recreate? The hardest? Why?

2. What is the relationship of the perimeter and area between your original square and the square you created? What is the relationship of the perimeter and area of the original square to the final class project?

3. If we did the project using 4" x 4" squares how would that have affected the perimeter and area?

Task #9: Scale Drawing Individual

Goal: To select a card and enlarge it to best fit an 8 ½ “ x 11” sheet of paper.

To investigate how dimensions, perimeter and area are affected when doing scale drawings.

Please include in your project:

1. The original picture
2. The enlarged picture (colored to match original)
3. Measurements of the original picture
4. The scale selected to enlarge the picture
5. Self-Completed Evaluation

Design:

Step 1: Measure the length and width of the picture in cm. (It does not matter which side you label the length and width; be consistent with your sides on the large paper)

Length _____ Width _____

Step 2: Draw a 1 cm grid on the original card (Draw 1 cm tick marks going across the length and the width and then connect your marks to form a grid, these measurements need to be accurate)

Step 3: Measure the paper in cm.

Length _____ Width _____

Step 4: Select a scale (1 cm on card = _____ cm on paper)

- To do this find the ratio of lengths and widths

i.e.: $\frac{L_p}{L_c} = \frac{\quad}{\quad} = \frac{\quad}{\quad}$ $\frac{W_p}{W_c} = \frac{\quad}{\quad} = \frac{\quad}{\quad}$

- Then pick the smallest of the two numbers to the nearest whole number (i.e. if you get 4.29 and 4.76 your scale should be 1 cm card = 4 cm on paper)

Step 5: Draw the borders

- Multiply your length and width of the card by your scale factor and see how much of the paper you have left over for the border. Take this number and divide by two because the border should be on both sides.

i.e. $L_c \times \text{Scale Factor} = \quad$ Then $(L_p - \quad)/2 = \quad$
 $W_c \times \text{Scale Factor} = \quad$ Then $(W_p - \quad)/2 = \quad$

Step 6: Draw a grid on your paper using your scale. (i.e. If your scale is 1:4, your grid on your large paper will be 4 cm x 4 cm; therefore, you would draw 4 cm tick marks going across the length and width and then connect your marks to form a grid.)

Step 7: Reconstruct drawing and color accordingly. Erase your grid marks on your final product before submitting the project! Higher scores will reflect a near-perfect representation of the smaller card frame. Colors, shading, and drawing should look identical!

1. What is the length and width of the squares of the small graph?

Length = _____ Width = _____

2. What is the length and width of the squares of the large graph?

Length = _____ Width = _____

3. What is the perimeter and area of each square on the small graph?

Perimeter = _____ Area = _____

4. What is the perimeter and area of each square on the large graph?

Perimeter = _____ Area = _____

5. How do the lengths of the small and large squares compare (answer as a fraction)?

Answer: _____

6. How do the widths of the small and large squares compare (answer as a fraction)?

Answer: _____

7. How do the perimeters compare (answer as a fraction)?

Answer: _____

8. How do the areas compare (answer as a fraction)?

Answer: _____

9. What is the length and width of the original card?

Length = _____ Width = _____

10. What is the length and width of the enlarged card?

Length = _____ Width = _____

11. What is the perimeter of the original card?

Perimeter = _____

12. What is the perimeter of the enlarged card?

Perimeter = _____

13. How do the two perimeters compare (answer as a fraction)?

Answer: _____

14. What is the area of the original card?

Area: _____

15. What is the area of the enlarged card?

Area: _____

16. How do the two areas compare (answer as a fraction)?

Answer: _____

17. Are the comparisons for perimeter and area the same? Explain why you think this happened.

Yes or No

Scale Drawing Project Rubric

NOTE: When you submit your project, you will first score yourself using this rubric. Be honest and thorough in your evaluation. Remember to include the following parts in your presentation:

1. The original picture
2. The enlarged picture (colored to match original)
3. Measurements of the original picture
4. The scale selected to enlarge the picture
5. Self-Completed Evaluation

	10 – 9	8 – 7	6 – 5	4 - 0
Scale	All calculations and proportions are shown.	Most calculations and proportions are shown.	Few calculations and proportions are shown.	No calculations and proportions are shown.
Grids	All grid lines can be seen on card (grid lines on enlarged picture should be erased, but should appear faintly). All lines are parallel and measured correctly.	Most grid lines can be seen on card (grid lines on enlarged picture should be erased, but should appear faintly). Most lines are parallel and measured correctly.	Few grid lines can be seen on card (grid lines on enlarged picture should be erased, but should appear faintly). Few lines are parallel and measured correctly.	No grid lines can be seen on card (grid lines on enlarged picture should be erased, but should appear faintly). No lines are parallel, nor measured correctly.
Reconstruction	All proportions are accurate on the enlarged picture.	Most proportions are accurate on the enlarged picture.	Few proportions are accurate on the enlarged picture.	No proportions are accurate on the enlarged picture.
Presentation	The enlarged picture is colored neatly in the lines and colors match original card.	Most of the enlarged picture is colored neatly in the lines and most of the colors match original card.	Some of the enlarged picture is colored neatly in the lines and some of the colors match original card.	The enlarged picture is not colored neatly in the lines and does not match original card.

Total Points Possible: 40

Self-Assessment:

Scale: _____/10

Grids: _____/10

Reconstruction: _____/10

Presentation: _____/10

Total Points: _____/40

Comment on your level of effort and accuracy on this project:

Teacher-Assessment:

Scale: _____/10

Grids: _____/10

Reconstruction: _____/10

Presentation: _____/10

Total Points: _____/40

Teacher Comments:

Adapted from the lesson Cartoons and Scale Drawings created by Sara Wheeler for the Alabama Learning Exchange. http://alex.state.al.us/lesson_view.php?id=26285

Task #10: Comparing TV Areas

Does an 80" TV Really Have More Than Twice the Area of a 55" TV?



1. What does the 80 inches represent in an 80" TV?

2. Find the area of an 80" TV if the ratio of the length to the height is 16:9.

3. Find the area of a 55" TV. The ratio of the length to the height is the same.

4. How much more area does the 80" TV have than the 55" TV?

5. Is the advertisement accurate?

Task #11: Area and Perimeter of Irregular Shapes

Find the area and perimeter of each of the following shapes.

1.

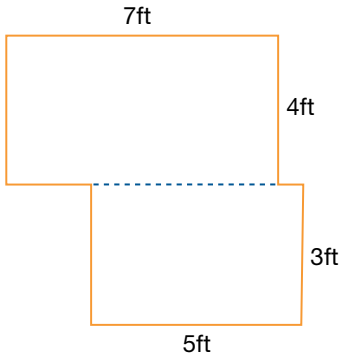

Perimeter = _____

Area = _____

2.

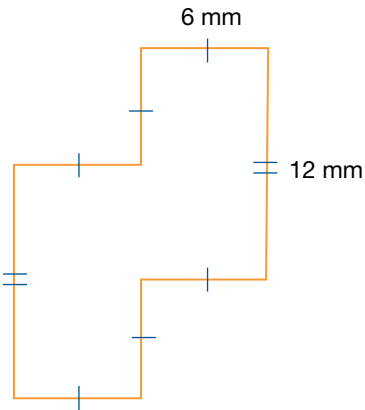

Perimeter = _____

Area = _____

3.

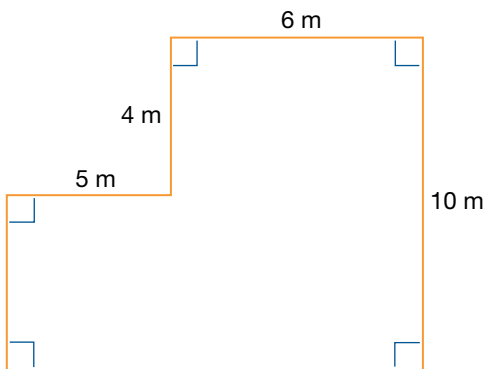

Perimeter = _____

Area = _____

4.

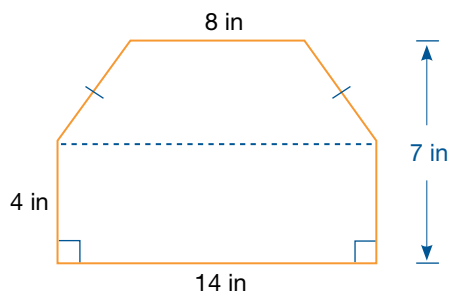

Perimeter = _____

Area = _____

5.

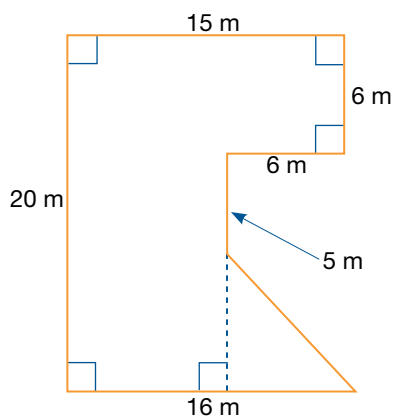

Perimeter = _____

Area = _____

(Source: freemathsource.com)

Task #12: Area Problems

Find the area and perimeter of each of the following shapes.

1. Find the largest possible rectangular area you can enclose with 96 meters of fencing. What is the (geometric) significance of the dimensions of this largest possible enclosure? What are the dimensions in meters? What are the dimensions in feet? What is the area in square feet?

2. The riding stables just received an unexpected rush of registrations for the next horse show, and quickly needs to create some additional paddock space. There is sufficient funding to rent 1200 feet of temporary chain-link fencing. The plan is to form two paddocks with one shared fence running down the middle. What is the maximum area that the stables can obtain, and what are the dimensions of each of the two paddocks?

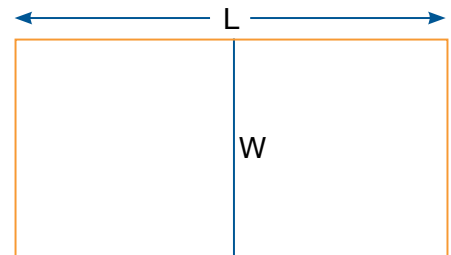

3. A farmer has a square field that measures 100 m on a side. He wants to irrigate as much of the field as he possibly can using a circular irrigation system.

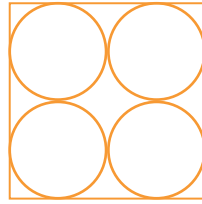
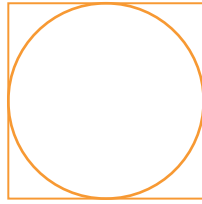

a. Predict which irrigation system will irrigate more land?

b. What percent of the field will be irrigated by the large system?

c. What percent of the field will be irrigated by the four smaller systems?

d. Which system will irrigate more land?

e. What generalization can you draw from your answers?

Task #13: Paper Clip Activity

This paper clip is just over 4 cm long.

How many paper clips like this can be made from a straight piece of wire 10 meters long?

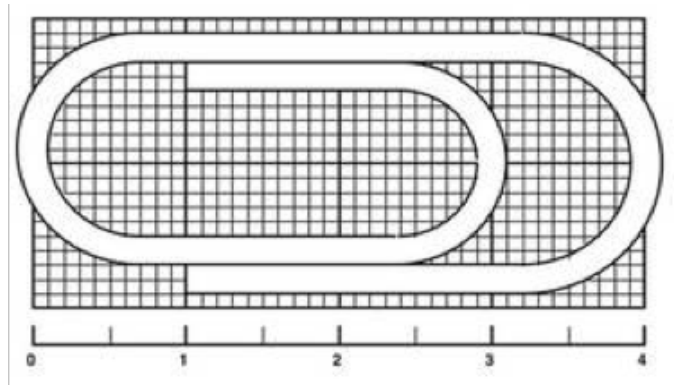

Task #14: Race Track Problem

A track has lanes that are 1 meter wide. The turn-radius of the inner lane is 24 meters and the straight parts are 80 meters long. In order to make the race fair, the starting lines are staggered so that each runner will run the same distance to the finish line.

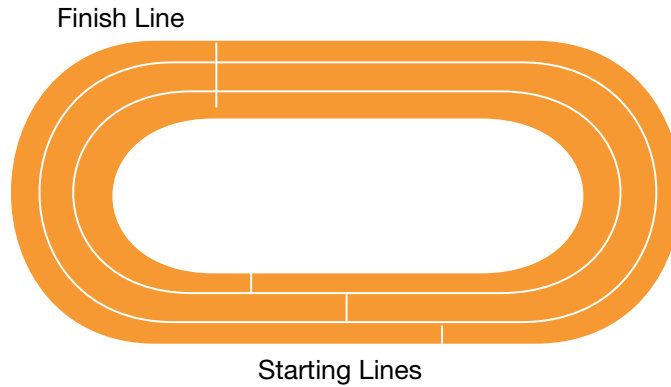

a. Find the distances between the starting lines in neighboring lanes.

b. Is the distance between the starting lanes for the first and second lane different from the distance between the starting lanes for the second and third lanes?

c. What assumptions did you make in doing your calculations?

Task #15: Area & Perimeter Exit Slip

DIRECTIONS: Calculate the perimeter and the area of each rectangle.

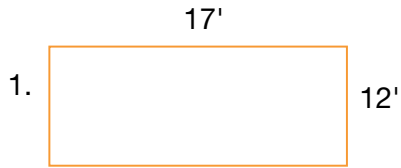

Perimeter = _____

Area = _____

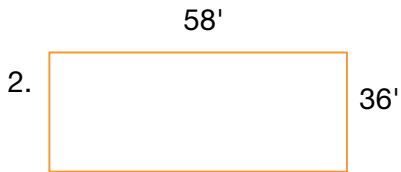

Perimeter = _____

Area = _____

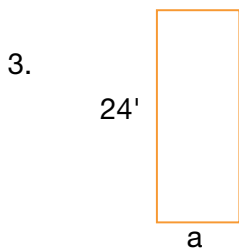

Perimeter = _____

Area = _____

4. A rectangle has an area of $2,130'$ and a width of $30'$, find its length and perimeter.

5. The perimeter of the triangle below is 52 cm. Find the length of each side of the triangle. Show your calculations.

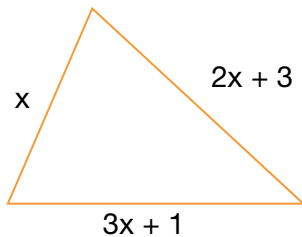

Task #16: Quadrilateral Activity

1. Points $A(1, 3)$, $B(-3, 1)$, $C(-1, -3)$, $D(3, -1)$ form a square
 - a. Graph the points and connect them.

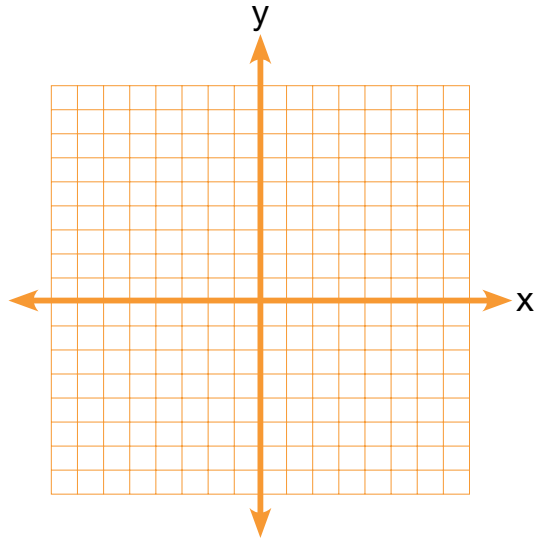

- b. List as many properties of a square as you can.

- c. Show algebraically that the property assigned to your group is true for this square and all squares.

- d. Find the area and perimeter of ABCD.

2. Consider the points $F(-4, -1)$, $G(-2, -5)$, $H(4, -2)$ and $J(2,2)$.

a. Graph the points.

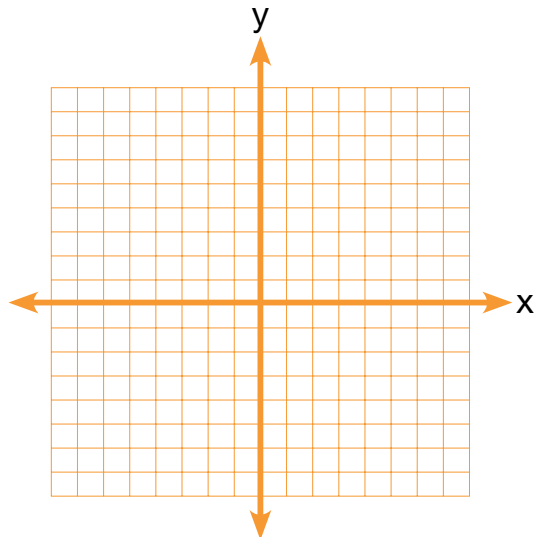

b. What type of quadrilateral is $FGHJ$? Justify your reasoning.

3. Consider the points $K(-2, -1)$, $L(-1, 2)$, $M(2, 4)$ and $N(1,1)$.

a. Graph the points.

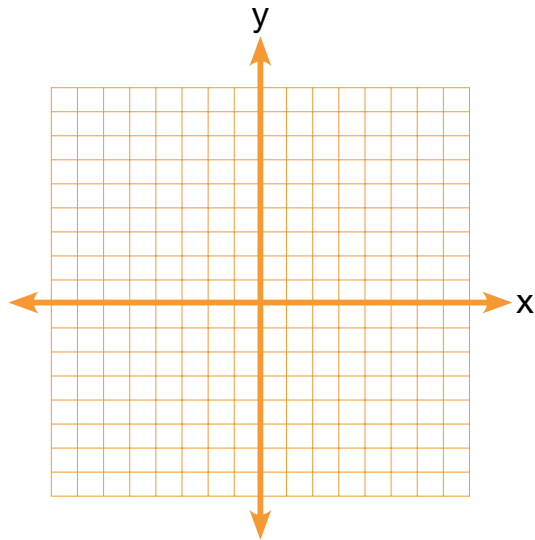

b. What type of quadrilateral is KLMN? Show your work and justify your reasoning.

Task #17: Propane Tank Activity

Propane Tanks

People who live in isolated or rural areas have their own tanks of natural gas to run appliances like stoves, washers, and water heaters.

These tanks are made in the shape of a cylinder with hemispheres on the ends.

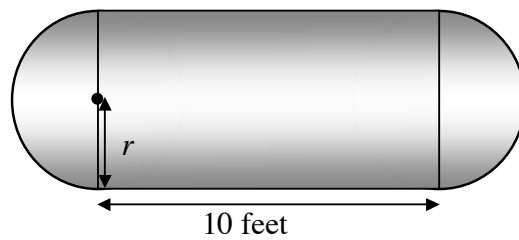

The Insane Propane Tank Company makes tanks with this shape, in different sizes.

The cylinder part of every tank is exactly 10 feet long, but the radius of the hemispheres, r , will be different depending on the size of the tank.

The company want to double the capacity of their standard tank, which is 6 feet in diameter.

What should the radius of the new tank be? _____

Explain your thinking and show your calculations.

Task #18: Toilet Roll

Picture a roll of toilet paper; assume that the paper in the roll is very tightly rolled. Assuming that the paper in the roll is very thin, find a relationship between the thickness of the paper, the inner and outer radii of the roll, and the length of the paper in the roll. Express your answer as an algebraic formula involving the four listed variables.

- R_i = inner radius
- R_o = outer radius
- t = thickness of the toilet paper
- L = length of the toilet paper

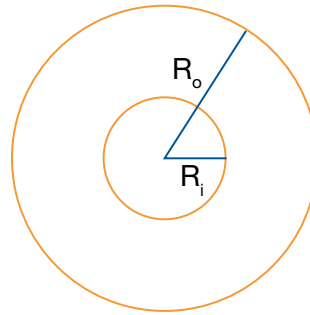

(Source: Illustrative Mathematics)

SREB Readiness Courses
Transitioning to college and careers

College Readiness Mathematics

Unit 4 . Linear Functions
Student Manual
Version 3

Name



Unit 4 . Linear Functions

Table of Contents

Lesson 1.....	3
Lesson 2.....	5
Lesson 3.....	12
Lesson 4.....	15
Lesson 6.....	21
Lesson 7.....	25

Frayer Map

Definitions		Characteristics	
Examples	Function		Non-Examples

Task #1: Journal Entry

For the situation, write a journal entry on the next page explaining how the rate of change can be identified in the written scenario, on the graph and in the table. Make sure to fully explain using mathematical language.

Isabella’s electric company charges \$0.15 per kWh (Kilowatt hour) plus a basic connection charge of \$20 per month.

kWh	Monthly bill
0	\$20
100	\$35
200	\$50
500	\$95
1000	\$170

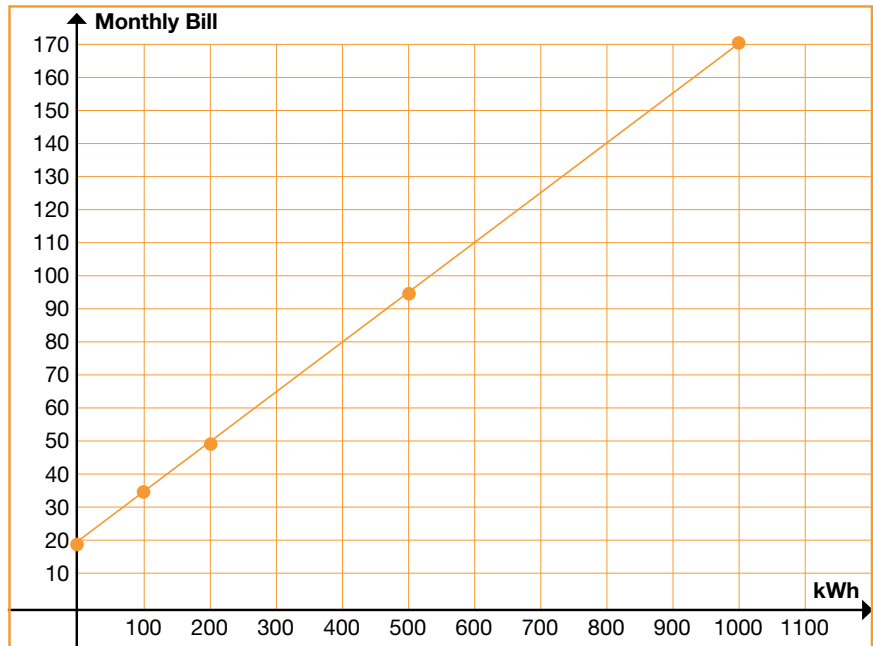

Task #2: Peaches and Plums

The graphs below show the cost y of buying x pounds of fruit. One graph shows the cost of buying x pounds of peaches, and the other shows the cost of buying x pounds of plums.

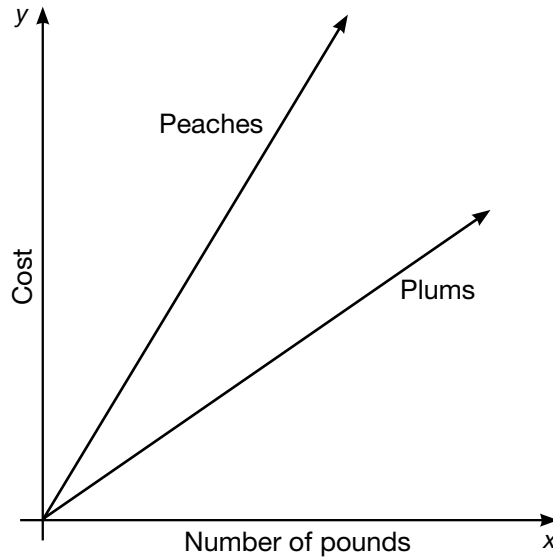

1. Which kind of fruit costs more per pound? Explain.

2. Bananas cost less per pound than peaches or plums. Draw a line alongside the other graphs that might represent the cost y of buying x pounds of bananas.

(Source: Illustrative Mathematics)

Task #3: Independent vs. Dependent

Independent vs. Dependent

For each situation, identify the independent and dependent variables.

- 1. The height of the grass in a yard over the summer.

Independent: _____

Dependent: _____

- 2. The number of buses needed to take different numbers of students on a field trip.

Independent: _____

Dependent: _____

- 3. The weight of your dog and the reading on the scale.

Independent: _____

Dependent: _____

- 4. The amount of time you spend in an airplane and the distance between your departure and your destination.

Independent: _____

Dependent: _____

- 5. The number of times you dip a wick into hot wax and the diameter of a handmade candle.

Independent: _____

Dependent: _____

- 6. The amount of money you owe the library and the number of days your book is overdue.

Independent: _____

Dependent: _____

7. The number of homework assignments you haven't turned in and your grade in math.

Independent: _____

Dependent: _____

8. The temperature of a carton of milk and the length of time it has been out of the refrigerator.

Independent: _____

Dependent: _____

9. The weight suspended from a rubber band and the length of the rubber band.

Independent: _____

Dependent: _____

10. The diameter of a pizza and its cost.

Independent: _____

Dependent: _____

11. The number of cars on the freeway and the level of exhaust fumes in the air.

Independent: _____

Dependent: _____

Task #4: Coffee by the Pound

Coffee by the Pound

Lena paid \$18.96 for 3 pounds of coffee.

a. What is the cost per pound for this coffee?

b. How many pounds of coffee could she buy for \$1.00?

c. Identify the independent and dependent variables for this problem.

d. Draw a graph in the coordinate plane of the relationship between the number of pounds of coffee and the price of coffee.

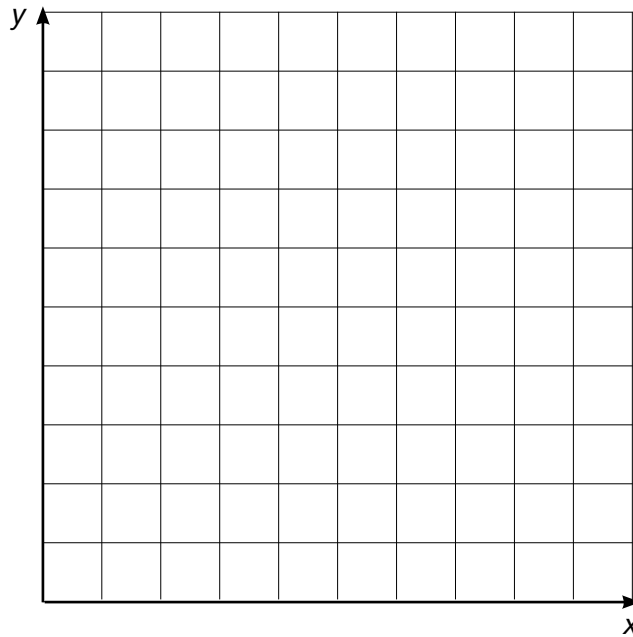

e. In this situation, what is the meaning of the slope of the line you drew in part (d)?

Task #5: Who Has the Best Job?

Kell works at an after-school program at an elementary school. The table below shows how much money he earned every day last week.

	Monday	Wednesday	Friday
Time Worked	1.5 hours	2.5 hours	4 hours
Money Earned	\$12.60	\$21.00	\$33.60

Mariko has a job mowing lawns that pays \$7 per hour.

- a. Who would make more money for working 10 hours? Explain or show your work.

b. Draw a graph that represents y , the amount of money Kell would make for working x hours, assuming he made the same hourly rate he was making last week.

c. Using the same coordinate axes, draw a graph that represents y , the amount of money Mariko would make for working x hours.

d. How can you see who makes more per hour just by looking at the graphs? Explain.

Task #6: Megan’s Disney Vacation

Megan and her family are travelling from their home in Nashville, TN to Orlando, FL on a Disney vacation. The trip is 685 miles and they will be travelling 65 miles per hour, on average.

Megan used the following equation to calculate the remaining distance throughout the trip:

$$D=685-65h$$

Discuss the following with your partner:

- The intercepts and slope and the meaning of each in the context of the problem.
- The independent and dependent variables.
- The domain and range.

Examine the graph of the equation below.

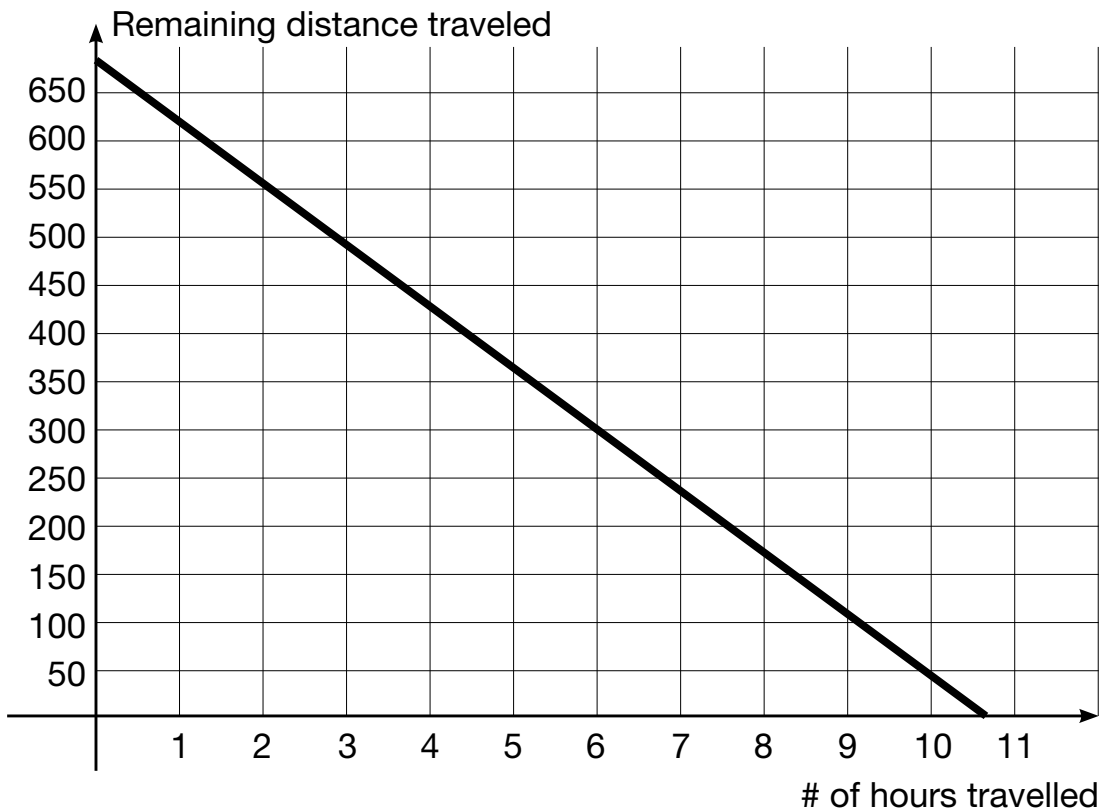

What steps might you take to graph this equation?

By studying the graph, where do you see the components of the graph mentioned above?

Exit Ticket: Graphing in Context

Carole owns a t-shirt company where she both designs and produces t-shirts for local individuals and businesses. Carole paid \$18,000 for the printing machine and it costs an additional \$5 for each t-shirt produced. An equation to model this situation is below:

$$C = 18,000 + 5t$$

1. What is the y-intercept and what does it mean in the context of this problem?

2. What is the slope and what does it mean in the context of this problem?

3. Graph the equation.

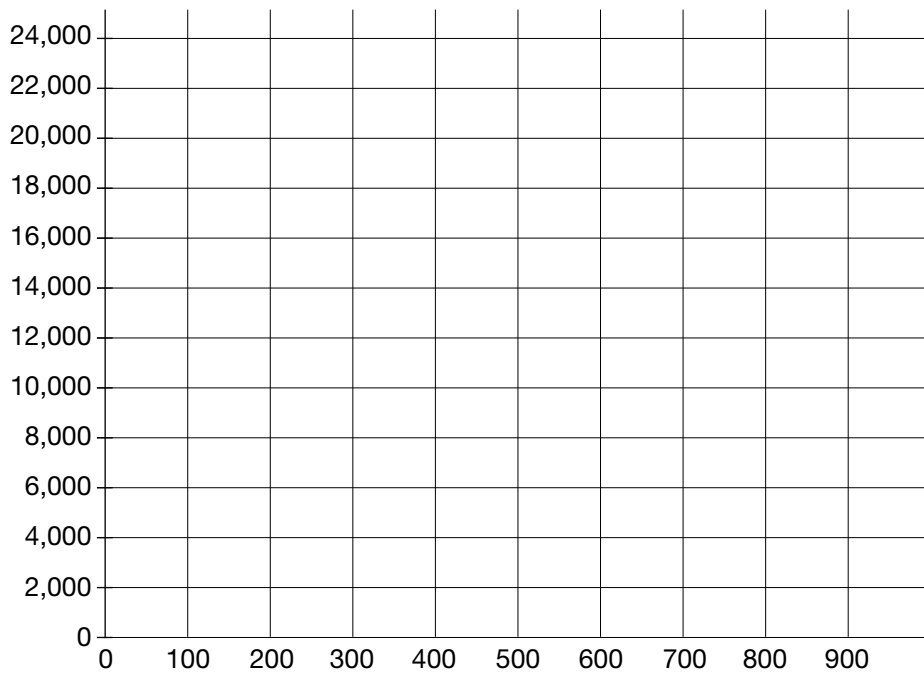

Task #7: Writing Linear Equations in Context

For each of the situations determine the slope, y-intercept, and x-intercept, along with each of their real-world meanings, when applicable. Additionally, write an equation to model the situation. Each equation should be written in the form most appropriate for the information provided.

- 1. To prepare for a recent road trip, Jill filled up her 19-gallon tank. She estimates that her SUV will use about three gallons per hour. Write an equation to model the amount of gasoline, G , remaining in her tank after t hours.

Slope: _____

Real-world meaning:

y-intercept: _____

Real-world meaning:

x-intercept: _____

Real-world meaning:

Equation: _____

- 2. Roberto deposits the same amount of money each month into a checking account. Use the table to write an equation to model his balance, B , after m months.

# of months	1	3	6
Balance	255	365	530

Slope: _____

Real-world meaning:

y-intercept: _____

Real-world meaning:

x-intercept: _____

Real-world meaning:

Equation: _____

- 3. Let f be the function that assigns to a temperature in degrees Celsius its equivalent in degrees

Fahrenheit. The freezing point of water in degrees Celsius is zero while in degrees Fahrenheit it is 32. The boiling point of water is 100 degrees Celsius and 212 degrees Fahrenheit. Given that the function f is linear, use this information to find an equation for f .

Slope: _____

Real-world meaning:

y-intercept: _____

Real-world meaning:

x-intercept: _____

Real-world meaning:

Equation: _____

4. At the beginning of October, Monique changed banks and decided to leave the remaining \$3900 in her old checking account to pay for rent. After six months, her balance was finally zero. If the balance, B , in Monique's account is a function of time, t , write an equation for the situation.

Slope: _____

Real-world meaning:

y-intercept: _____

Real-world meaning:

x-intercept: _____

Real-world meaning:

Equation: _____

5. On a recent scuba diving trip, Kate and Kara reached a depth of 130 feet. Six-and-a-half minutes later after ascending at a constant rate, they reached the surface. Write an equation to represent their distance, D , as a function of time, t .

Slope: _____

Real-world meaning:

y-intercept: _____

Real-world meaning:

x-intercept: _____

Real-world meaning:

Equation: _____

Task #8: More Modeling with Functions

1. A student has had a collection of baseball cards for several years. Suppose that B , the number of cards in the collection, can be described as a function of t , which is time in years since the collection was started. Explain what each of the following equations would tell us about the number of cards in the collection over time.

(a) $B = 200 + 100t$

(b) $B = 100 + 200t$

(c) $B = 2000 - 100t$

(d) $B = 100 - 200t$

2. Which of the following could be modeled by $y = 2x + 5$? Answer YES or NO for each one.

(a) There are initially five rabbits on the farm. Each month thereafter the number of rabbits is two times the number in the month before. How many rabbits are there after x months?

Yes No

(b) Joaquin earns \$2.00 for each magazine sale. Each time he sells a magazine he also gets a five-dollar tip. How much money will he earn after selling x magazines?

Yes No

(c) Sandy charges \$2.00 an hour for babysitting. Parents are charged \$5.00 if they arrive home later than scheduled. Assuming the parents arrived late, how much money does she earn for x hours?

Yes No

(d) I have a sequence of integers. The first term of the sequence is 7 and the difference between any consecutive terms is always equal to two.

Yes No

(e) Sneak Preview is a members-only video rental store. There is a \$2.00 initiation fee and a \$5.00 per video rental fee. How much would John owe on his first visit if he becomes a member and rents x videos?

Yes No

(f) Andy is saving money for a new CD player. He began saving with a \$5.00 gift and will continue to save \$2.00 each week. How much money will he have saved at the end of x weeks?

Yes No

3. A checking account is set up with an initial balance of \$4800, and \$400 is removed from the account each month for rent (no other transactions occur on the account).

(a) Write an equation whose solution is the number of months, m , it takes for the account balance to reach \$2000.

(b) Make a plot of the balance after m months for $m=1,3,5,7,9,11$ and indicate on the plot the solution to your equation in part (a).

Independent Practice

Write an equation to model each of the situations.

1. Cedric and Josh both ordered the same size pizzas at Marco's Pizzeria; however, they ordered different toppings. Marco's charges an additional fee for toppings, but all toppings cost the same. Cedric got pepperoni, banana peppers, and black olives on his pizza for a cost of \$15.74. Josh ordered mushrooms and eggplant on his pizza and paid \$14.49. Using this information, write an equation for the cost of a pizza, C , as a function of the number of toppings, t ordered.

2. College tuition at Bedrock University has increased \$500 per year for the past six years. Wilma is a freshmen this year and paid \$10,250 for her tuition. She is curious about her tuition in the coming years and needs this information as motivation to graduate in four years. Assuming the tuition rate increase remains constant, write an equation to represent the tuition at Bedrock University in x years.

3. Moche started a summer business of mowing lawns. However, before he could mow lawns, he needed to purchase supplies (a lawnmower among other needs). Moche spent \$395 gathering necessary materials. He makes on average \$60 per lawn, mowed. Write an equation to show Moche his earnings for l lawns mowed.

4. Margaret purchased a new bar of soap. Three days after she originally used the soap, she was curious how much soap per day she was using. She decided to weigh her soap and found that the bar was 103 grams. Four days later she re-measured the same bar of soap and recorded a weight of 80 grams. Assuming that Margaret uses the same amount of soap daily (and that she used the soap daily), write an equation that shows the amount of soap remaining after d days of use.

Task #9: Water Balloon Bungee Activity Report

Follow this outline to produce a neat, organized, thorough, and accurate report, with at least one paragraph for each section. Any reader of your report should be able to understand the activity without having participated in it.

A. Overview

Tell what the investigation was about by explaining its purpose or objective.

B. Data collection

Describe the data you collected and how you collected it.

C. Model

Provide your equation for the line of best fit. Tell how you found this equation and how your group chose this equation to represent your data.

D. Calculations

Explain how you determined how many rubber bands to use in the final jump. Show any calculations used to find the result.

E. Results

Describe what happened on the final jump. How did your water balloon compare with the others?

F. Conclusion

What problems did you have in this activity?

What worked well?

If you could repeat the whole experiment, what would you do to improve your results?

Independent Practice

Jackson is in charge of creating the work schedule for employees at Big Waves Water Park. If too many employees are scheduled, the water park loses money. On the other hand, if too few employees are scheduled on a busy day, customers are unhappy and the water park could lose business. Jackson knows there is a relationship between the daily temperature and the number of customers, which, in turn, determines the number of employees needed.

Use the data below to do the following:

- a. Graph the data.
- b. Find an equation for the line of best fit.
- c. Predict the number of employees needed when the temperature is 77°.

Temperature forecast (F°)	65	70	75	80	85	90
Number of employees	15	19	27	31	36	40

Extension: On a day when the temperature is 85°, there are approximately 550 customers at the park. Use this information to predict the number of customers on a 97° day.

Task #10: iTunes App Downloads**iTunes App Downloads**

In this activity, you will use your knowledge of algebra to make a prediction on when the 25 billionth iTunes app was downloaded.

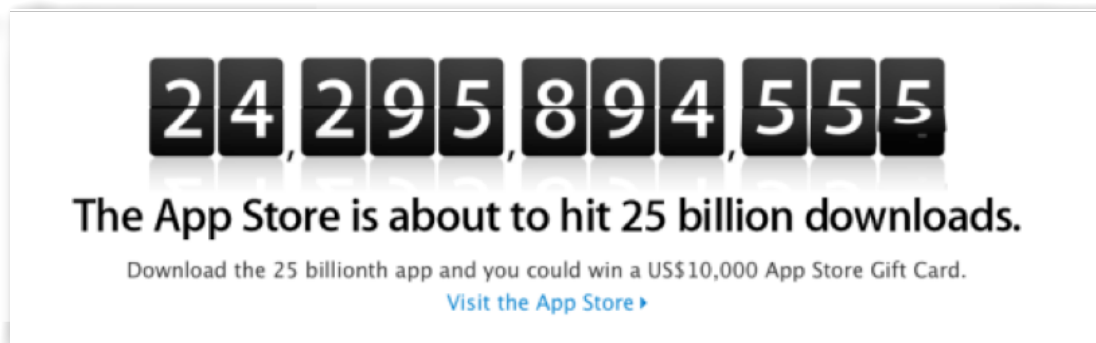

Use information provided in the 16-minute video clip (<http://vimeo.com/37382647>) to make a prediction on when the 25 billionth iTunes app was actually downloaded. You may decide exactly how your data will be collected but you must share your data in a table and a graph. After your data has been collected and recorded in a table and a graph, answer the following questions.

1. Find an equation that best models your data.
2. Graph your equation on the same graph with your data. Explain the key features of your graph and what they mean in the context of this problem.
3. Use your equation and other information provided in the video segment to predict the date of the 25 billionth download from the iTunes app store.

SREB Readiness Courses
Transitioning to college and careers

College Readiness Mathematics

Unit 5 . Linear Systems
of Equations
Student Manual
Version 3

Name



Unit 5 . Linear Systems of Equations

Table of Contents

Pre-Unit Assessment	3
Lesson 1.....	4
Lesson 2.....	14
Lesson 3.....	18
Lesson 4.....	25
Lesson 5.....	28
Lesson 6.....	43

Entry Event Activity

Wartime Battle

During war games, it is your job to navigate one of our battleships. Your course takes you over several enemy paths. As part of your duties, you must lay mines along the enemy's path. However, in order to plant the mines, you must know the points at which the paths cross and report those points to the Captain and to the Mine Crew. You know of 3 different enemy paths, which are denoted by the following equations:

Enemy Path 1: $x = 3y - 15$

Enemy Path 2: $4x - y = 7$

Enemy Path 3: $y = -1 - 2x$

Your battleship's course is denoted by this equation:

Battleship: $x + y = -5$

Using graph paper and colored pencils, determine where you need to plant the mines.

	(x, y) intersection
Enemy Path 1	
Enemy Path 2	
Enemy Path 3	

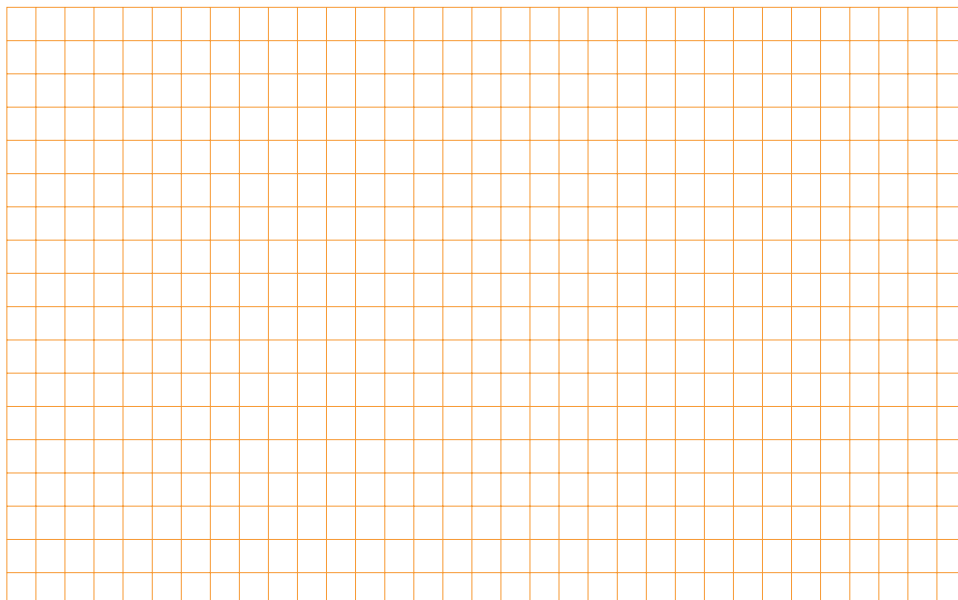

Task #1: Comparing Phone Plans

APlus telecommunications offers a plan of \$20 per month for an unlimited calling and data plan and 10 cents per text message sent. TalkMore, a competing company, offers a plan of \$55.00 per month for an identical unlimited calling and data plan and five cents per text message.

How can you determine which plan will be cheaper for you?

Task #2: Systems Activity

Work in teams of three or four (person A, person B, and person C). Each student is to complete his or her worksheet using the method as prescribed on the sheet, showing all work for each problem.

When you are finished, compare solutions for each corresponding system. Write the agreed upon solution in the appropriate column. Then discuss how you arrived at your solution. Was the method you used easier or more difficult than the others? Decide which method or methods the group found to be the ‘best’ or ‘preferred’ for each system (graphing, substitution or elimination). Give a reason for your answer. Simply saying, “it was the easiest method,” is not sufficient. Explain WHY you found the method to be the best—what made it easier?

SYSTEM	Solution	Preferred Method(s)	Reason
System 1 $\begin{cases} x + y = 4 \\ 2x - y = 5 \end{cases}$			
System 2 $\begin{cases} y = 4x + 6 \\ 2x - 3y = 7 \end{cases}$			
System 3 $\begin{cases} 3x + 2y = 8 \\ 5x - 3y = 7 \end{cases}$			

Person A

Graphing Method

$x + y = 4$

$2x - y = 5$

Substitution Method

$y = 4x + 6$

$2x - 3y = 7$

Elimination Method

$3x + 2y = 8$

$5x - 3y = 7$

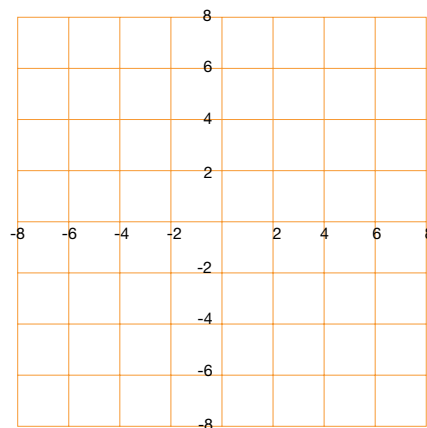

Person B

Graphing Method

$$3x + 2y = 8$$

$$5x - 3y = 7$$

Substitution Method

$$x + y = 4$$

$$2x - y = 5$$

Elimination Method

$$y = 4x + 6$$

$$2x - 3y = 7$$

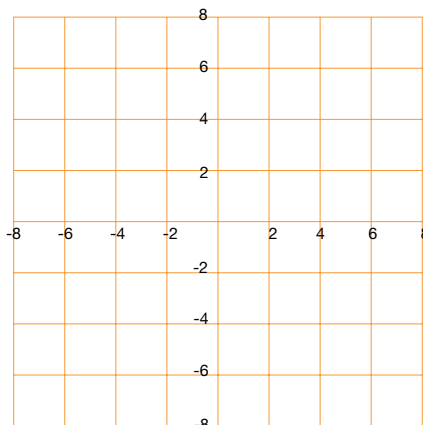

Person C

Graphing Method

$$y = 4x + 6$$

$$2x - 3y = 7$$

Substitution Method

$$3x + 2y = 8$$

$$5x - 3y = 7$$

Elimination Method

$$x + y = 4$$

$$2x - y = 5$$

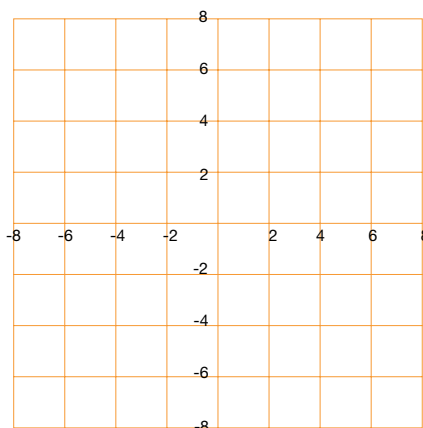

Task #3: Classifying Solutions

Solve each system of equations in the following ways:

- a) Graphing.
- b) Algebraically— substitution or elimination (addition).

1) $2x + 3y = 9$
 $-4x - 6y = -18$

a. Solve graphically.

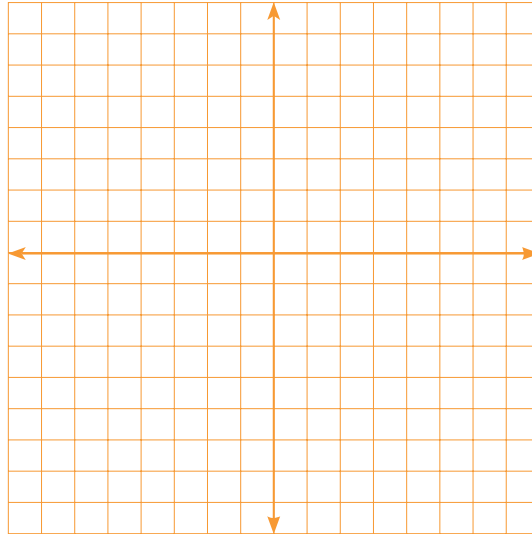

b. Solve algebraically.

c. What do you notice about the lines?

d. What is the solution? Where do the lines intersect? How many solutions exist?

e. Is the system consistent or inconsistent? Are the equations dependent or independent?

2) $x - 2y = 8$
 $3x - 6y = 6$

a. Solve graphically.

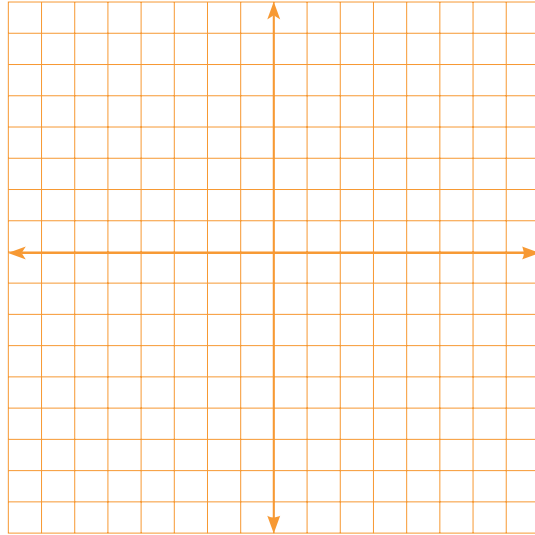

b. Solve algebraically.

c. What do you notice about the lines?

d. What is the solution? Where do the lines intersect? How many solutions exist?

e. Is the system consistent or inconsistent? Are the equations dependent or independent?

3) $-x + y = -2$
 $3x + y = 2$

a. Solve graphically.

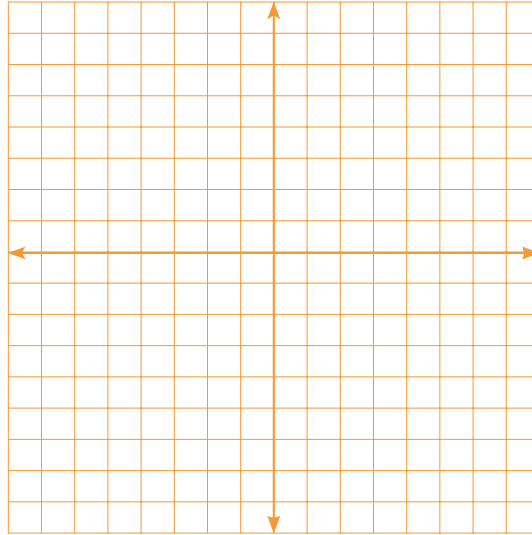

b. Solve algebraically.

c. What do you notice about the lines?

d. What is the solution? Where do the lines intersect? How many solutions exist?

e. Is the system consistent or inconsistent? Are the equations dependent or independent?

Task #4: Systems of Equations Practice Problems

Solve the following systems of equations by any method. Indicate if there is no solution or infinitely many solutions.

1. $2y - 4 = 0$
 $x + 2y = 5$

2. $3x + 8y = 18$
 $x + 2y = 4$

3. $2y - 4x = -4$
 $y = -2 + 2x$

4. $2x - 4y = 5$
 $3x + 5y = 2$

5. $f(x) = -4x + 15$
 $g(x) = 3x - 6$

6. $3y = 6 + x$
 $3x - 9y = 9$

7. $3x - 5y = 1$
 $7x - 8y = 17$

8. $y = -\frac{3}{4}x$
 $3x + 2y = 6$

Task #5: Best Buy Tickets

Susie is organizing the printing of tickets for a show her friends are producing. She has collected prices from several printers and these two seem to be the best. Susie wants to go for the best buy. She doesn't yet know how many people are going to come. Show Susie a couple of ways in which she could make the right decision, whatever the number. Illustrate your advice with a couple of examples.

SURE PRINT
Ticket printing
25 tickets for \$2

BEST PRINT

Tickets printed
\$10 setting up
plus
\$1 for \$25 tickets

Task #6: Dimes and Quarters and Sum of Digits

1) The only coins that Alexis has are dimes and quarters. Her coins have a total value of \$5.80. She has a total of 40 coins. How many does she have of each coin?

(<http://www.illustrativemathematics.org/illustrations/220>)

2) The sum of the digits of a two-digit number is seven. When the digits are reversed, the number is increased by 27. Find the number.

Stapel, Elizabeth. "System-of-Equations Word Problems." Purplemath. Available from <http://www.purplemath.com/modules/systprob.htm>. Accessed 17 September 2012

4. Guess the number. The number has two digits. The sum of the digits is eight. If the digits are reversed, the result is 18 less than the original number. What is the original number?
5. Samantha took out two loans totaling \$6,000 to pay for her first year of college. She borrowed the maximum amount she could at 3.5% simple annual interest and the remainder at 7% simple annual interest. At the end of the first year, she owed \$259 in interest. How much was borrowed at each rate?

Task #8: How Many Solutions?

Consider the equation $5x - 2y = 3$. If possible, find a second linear equation to create a system of equations that has:

- Exactly one solution.
- Exactly two solutions.
- No solutions.
- Infinitely many solutions.

Bonus Question: In each case, how many such equations can you find?

(Source: Illustrative Mathematics)

Task #9: Zoo

To enter a zoo, adult visitors must pay \$5, whereas children and seniors pay only half price. On one day, the zoo collected a total of \$765. If the zoo had 223 visitors that day, how many half-price admissions and how many full-price admissions did the zoo collect?

Task #10: Part I: BurgerRama Cartoon Dolls

Joan King is marketing director for the BurgerRama restaurant chain. BurgerRama has decided to have a cartoon-character doll made to sell at a premium price at participating BurgerRama locations. The company can choose from several different versions of the doll that sell at different prices. King’s problem is to decide which selling price will best suit the needs of BurgerRama’s customers and store managers. King has data from previous similar promotions to help her make a decision.

Selling Price of Each Doll	Number Supplied per Week per Store	Number Requested per Week per Store
\$1.00	35	530
\$2.00	130	400
\$4.00	320	140

1. Use the data from the table above to plot points representing selling price and supply price on a graph. (Selling Price of Each Doll should appear on the x-axis, and Number of Dolls Per Week per Store should appear on the y-axis.) Draw the line through the data points and write the word “Supply” on this line.
2. Plot points representing selling price and number requested (demand) on the same graph. Draw the line through these points. Write the word “Demand” on this line.

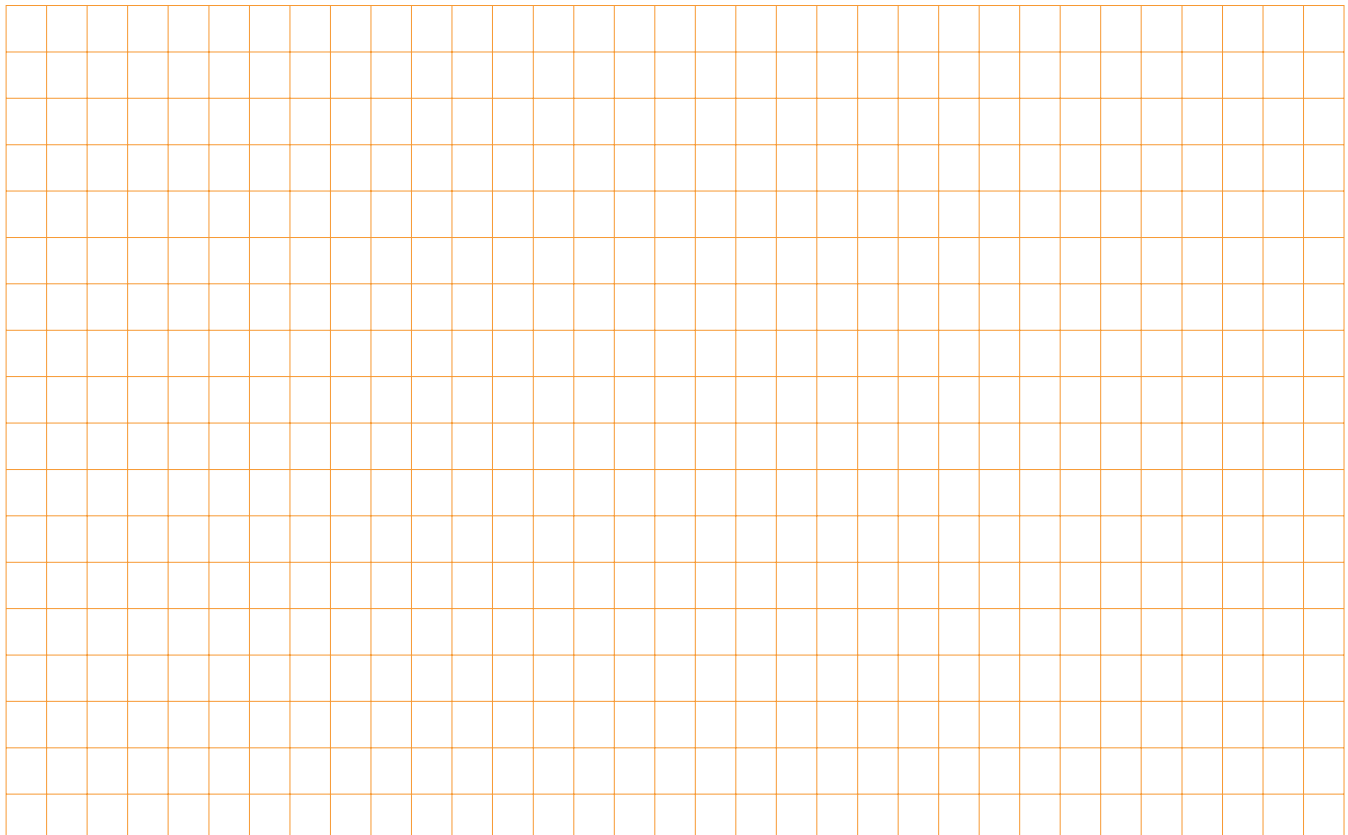

3. Use your graph to answer the following questions.

a. If King sets the price at \$2.50 per doll, how many disappointed customers will each store have during the week?

b. If King sets the price at \$3.80 per doll, how many unsold dolls will remain at each store at the end of a week?

c. According to this graph, if the company could give the dolls away, how many would each store need per week?

d. According to this graph, what price would make the doll supply so tight that the average number available to each store would be zero?

e. Estimate the price where supply and demand will be in equilibrium.

4. Complete the following using equations:

a. Use two of the points given to find the equation for supply (S) as a function of price (P).

b. Use two of the points given to find the equation for demand (D) as a function of price (P).

c. Solve the system of supply-and-demand equations to find the price in exact equilibrium. How does this price compare with your answer in question 3e above?

Task #11: Solving Problems with Two or More Equations

1. Which is the better value when renting a vehicle? Show your work or explain your answer.

Rent-A-Hunk o’ Junk charges \$29.95 per day and 43¢ per mile.

Tom’s Total Wrecks charges \$45 per day plus 32¢ per mile.

2. A landscaping company placed two orders with a nursery. The first order was for 13 bushes and four trees, and totaled \$487. The second order was for six bushes and two trees, and totaled \$232. The bills do not list the per-item price. What were the costs of one bush and of one tree? Show your work or explain your answer.

3. Below is data on four cyclists riding along a road through the Black Hills. The variable x represents the time the cyclist has been riding and y represents the cyclist’s distance in kilometers from Rapid City. Not all of the cyclists started their ride at Rapid City, but all of them left at the same time and are riding in the same direction.

Dan:

Hours	Kilometers
1	70
4	145

Maria:

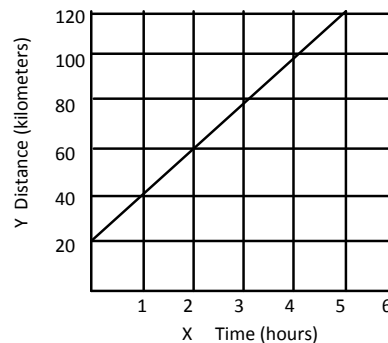

Ryan: $y = 30x$.

Helen: Started cycling 15 kilometers from Rapid City and traveled 50 kilometers in two hours.

a) Who is cycling the fastest? Who is cycling the slowest? Explain.

b) Will Ryan pass Dan? If so, when?

c) Will Helen pass Maria? If so, when?

d) Will Helen pass Dan? If so, when?

e) Write a linear equation for each of the cyclists. Graph the equations using graph paper or a graphing calculator. Explain how the graphs relate to your answers above.

Task #12: Part II: Video Games

The data provided in the table below show the supply and demand for video games at a toy warehouse.

Price	Supply	Demand
\$20	150	500
\$30	250	400
\$50	450	200

1. Find the supply equation.

2. Find the demand equation.

3. Find the price in equilibrium.

Task #12 (contd.): Part III Silver Dollars

Yousef likes to buy and sell coins at the flea market on weekends. He is especially interested in Susan B. Anthony silver dollars. By his own trial-and-error experiences and by information gained from other traders, Yousef has found the following data:

Selling Price	Number in Supply	Number in Demand
\$1.40	10	90
\$2.00	19	50
\$3.00	42	25
\$4.20	94	20

1. On graph paper, graph the price-supply points.
2. On the same graph, graph the price-demand points.
3. Use the graph to estimate the price in equilibrium.
4. Sketch a line that comes close to containing the price-supply points.
5. Sketch a line that comes close to containing the price-demand points.
6. What are the coordinates of the point where these two lines intersect? How does this answer compare with your answer in question 3?

Task #13: Boomerangs

Phil and Cath make and sell boomerangs for a school event. The money they raise will go to charity. They plan to make them in two sizes—small and large.

- Phil will carve them from wood. The small boomerang takes two hours to carve and the large one takes three hours to carve. Phil has a total of 24 hours available for carving.
- Cath will decorate them. She only has time to decorate 10 boomerangs of either size.
- The small boomerang will make \$8 for charity. The large boomerang will make \$10 for charity.

They want to make as much money for charity as they can. How many small and large boomerangs should they make? How much money will they then make?

Task #14: Writing Constraints

In (a)–(d), (i) write a constraint equation, (ii) determine two solutions, and (iii) graph the equation and mark your solutions.

a. The relation between quantity of chicken and quantity of steak if chicken costs \$1.29/lb and steak costs \$3.49/lb and you have \$100 to spend on a barbecue.

b. The relation between the time spent walking and driving if you walk at 3 mph then hitch a ride in a car traveling at 75 mph, covering a total distance of 60 miles.

Source: Illustrative Mathematics

c. The relation between the volume of titanium and iron in a bicycle weighing 5 kg, if titanium has a density of 4.5g/cm^3 and iron has a density of 7.87g/cm^3 (ignore other materials).

d. The relation between the time spent walking and the time spent canoeing on a 30 mile trip if you walk at 4 mph and canoe at 7 mph.

Task #15: Fishing Adventure 3

Fishing Adventures rents small fishing boats to tourists for day long fishing trips. Each boat can hold at most eight people. Additionally, each boat can only carry 1200 pounds of people and gear for safety reasons. Assume on average an adult weighs 150 pounds and a child weighs 75 pounds. Also, assume each group will require 200 pounds of gear plus 10 pounds of gear per person.

- Write an inequality that illustrates the weight limit for a group of adults and children on the fishing boat and a second inequality that represents the total number of passengers in the fishing boat. Graph the solution set to the inequalities.

- Several groups of people wish to rent a boat. Group 1 has four adults and two children. Group 2 has three adults and five children. Group 3 has eight adults. Which of the groups, if any, can safely rent a boat? What other combinations of adults and children are possible?

(Source: Illustrative Mathematics)

Task #16: Solution Sets

Given below are the graphs of two lines, $y = -0.5x + 5$ and $y = -1.25x + 8$, and several regions and points are shown. Note that C is the region that appears completely white in the graph.

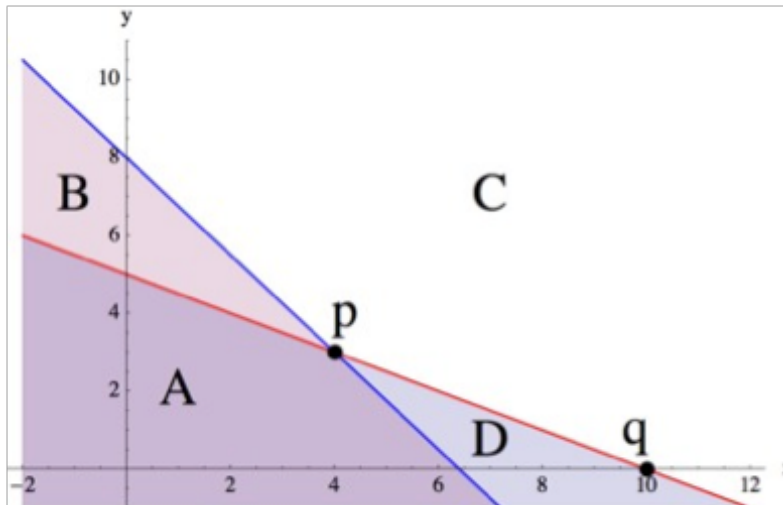

- For each region and each point, write a system of equations or inequalities, using the given two lines, that has the region or point as its solution set and explain the choice of \leq , \geq , or $=$ in each case. (You may assume that the line is part of each region.)

(Source: Illustrative Mathematics)

- The coordinates of a point within a region have to satisfy the corresponding system of inequalities. Verify this by picking a specific point in each region and showing that the coordinates of this point satisfy the corresponding system of inequalities for that region.

In the previous part, we checked that specific coordinate points satisfied our inequalities for each region. Without picking any specific numbers, use the same idea to explain how you know that all points in the third quadrant must satisfy the inequalities for region A.

Task #17: Minimize Cost

You are the assistant manager of an electronics store. Next month you will order two types of tablet PCs. How many of each model (A or B) should you order to minimize your cost?

- Model A: Your cost is \$300 and your profit is \$40.
- Model B: Your cost is \$400 and your profit is \$60.
- You expect a profit of at least \$4,800.
- You expect to sell at least 100 units.

Task #18: Dirt Bike Dilemma**Dirt Bike Dilemma**

NAME _____

The Annual Springfield Dirt Bike Competition is coming up, and participants are looking for bikes! Of course, they turn to Apu, who has the best bikes in town.

Apu has 18 wheels, 15 seats, and 14 exhaust pipes in his supply room. He can use these parts to assemble two different types of bikes: The Rider, or The Rover.

The Rider has 2 wheels, 1 seat, and 2 exhaust pipes. It is designed to glide around curves effortlessly.

The Rover has 3 wheels, 3 seats, and 1 exhaust pipe. It is designed to carry multiple passengers over the roughest terrain.

Apu needs to decide how many of each bike he should assemble to maximize his profit. Because of the popularity of the Dirt Bike Competition, he knows that no matter how many bikes he assembles, he will be able to sell all of them. Apu requests your assistance in making this decision.

Every member of your team should have the following items:

- Graphing Calculator
- Dirt Bike Dilemma Activity Sheet
- Three (3) Colored Pencils
- Set of Cards

In addition, each member of your team should get some cards:

- One member of your team should get 18 Wheel Cards. This person should complete Question 1.
- Another member of your team should get 14 Exhaust Pipe Cards. This person should complete Question 2.
- The last member of your team should get 15 Seat Cards. This person should complete Question 3.

1. Given 18 wheels, list all possible combinations of Riders and Rovers that can be assembled. Remember that each Rider needs two wheels and each Rover needs three wheels. Using only the wheel cards, complete the table. Plot the data on the grid below. (The possible combinations from the first two rows have been plotted for you.)

NUMBER OF RIDERS	POSSIBLE NUMBER OF ROVERS
0	0, 1, 2, 3, 4, 5, 6
1	0, 1, 2, 3, 4, 5
2	
3	
4	
5	
6	
7	
8	
9	

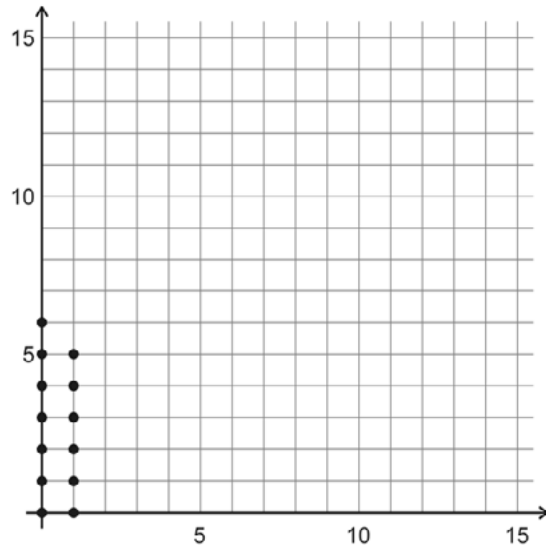

- a. What do you notice about the graph?

- b. On your graph, draw a line that borders all the points. This line should pass through *some* of the points that represent the maximum number of Rovers.

What inequality could be used to represent this relationship? _____
 This inequality is called a *restriction* or a *constraint*.

- c. How can you arrive at this inequality without the use of the table and graph?

2. Given 14 exhaust pipes, list all possible combinations of Riders and Rovers that can be assembled. Remember that each Rider needs two exhaust pipes and each Rover needs one exhaust pipe. Using only the exhaust pipe cards, complete the table. Plot the data on the grid below. (The possible combinations from the first two rows have been plotted for you.)

NUMBER OF RIDERS	POSSIBLE NUMBER OF ROVERS
0	0, 1, 2, ..., 14
1	0, 1, 2, ..., 12
2	
3	
4	
5	
6	
7	

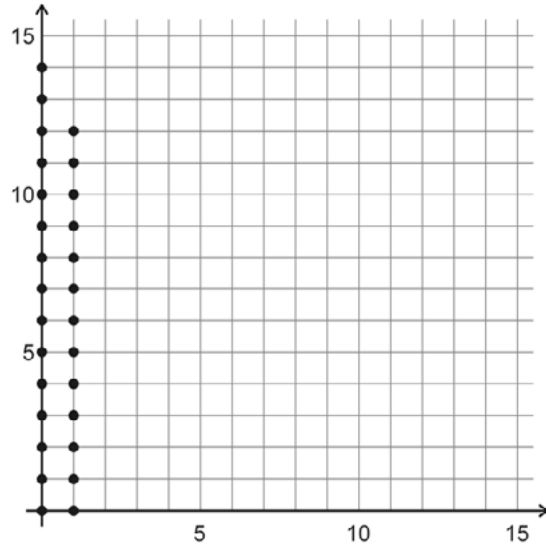

- a. What do you notice about the graph?

- b. On your graph, draw a line that borders all the points. This line should pass through *all* of the points that represent the maximum number of Rovers.

What inequality could be used to represent this relationship? _____
 This inequality is called a *restriction* or a *constraint*.

- c. How can you arrive at this inequality without the use of the table and graph?

3. Given 15 seats, list all possible combinations of Riders and Rovers that can be assembled. Remember that each Rider needs one seat and each Rover needs three seats. Using only the seat cards, complete the table. Plot the data on the grid below. (The possible combinations from the first two rows have been plotted for you.)

NUMBER OF RIDERS	POSSIBLE NUMBER OF ROVERS
0	0, 1, 2, 3, 4, 5
1	0, 1, 2, 3, 4
2	
3	
4	
5	
6	
7	
8	
9	
10	
11	
12	
13	
14	
15	

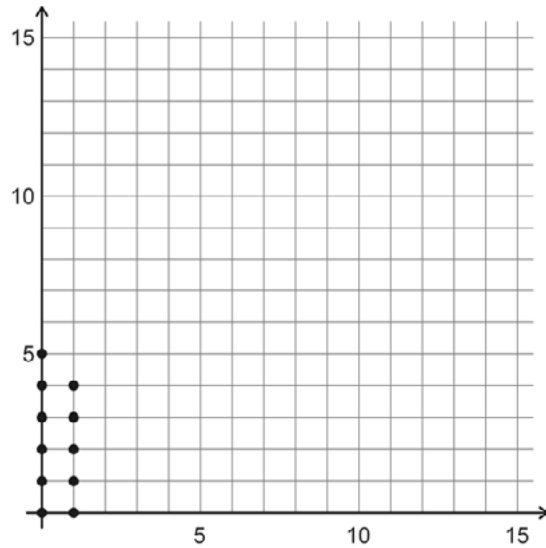

- a. What do you notice about the graph?

- b. On your graph, draw a line that encloses all the points. This line should pass through some of the points that represent the maximum number of Rovers.

What inequality would represent this relationship? _____
 This inequality is called a *restriction* or a *constraint*.

c. How can you arrive at this inequality without the use of the table and graph?

4. Discuss your answers with your team members. Explain how you arrived at your responses. Based on your discussion, complete Questions 1 through 3.

If all of the ordered pairs (Rider, Rover) that are feasible options are identified in the three graphs above, explain why each statement below is true.

a. All ordered pairs have integer coordinates.

b. When graphed in the coordinate plane, all ordered pairs will be located in either the first quadrant or on the positive x -axis or y -axis.

5. Below, list the three inequalities from Questions 1b, 2b, and 3b. Since all feasible ordered pairs (Rider, Rover) must be located either in the first quadrant or on one of the positive axes, what TWO additional inequalities should also be added to this list? Add them below.

6. Put all of your cards together. As a team, using the cards and the information from Questions 1-3, determine all possible combinations of Riders and Rovers that can be assembled with 18 wheels, 15 seats, and 14 exhaust pipes. Remember that each Rider needs 2 wheels, 1 seat, and 2 exhaust pipes, and each Rover needs 3 wheels, 3 seats and 1 exhaust pipe. Complete the table below, and plot your data on the grid.

NUMBER OF RIDERS	POSSIBLE NUMBER OF ROVERS
0	
1	
2	
3	
4	
5	
6	
7	
8	
9	

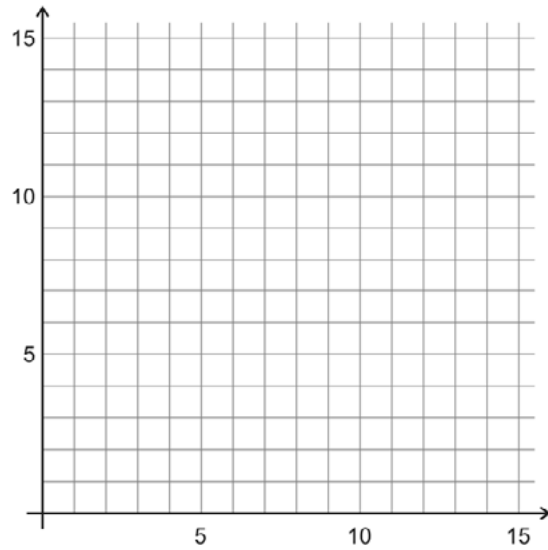

7. Carefully graph all five inequalities from Questions 5 on the grid in Question 6. What do you notice?

The region bounded by these inequalities is called the *feasible region*. The feasible region is the region that satisfies **all** of the constraints.

8. Suppose Apu makes a profit of \$15 for each Rider and \$30 for each Rover. Select two points from the feasible region to determine the total profit that Apu would receive. Show how you arrived at your answers.

a. First point in the feasible region: (_____ , _____)

b. Second point in the feasible region: (_____ , _____)

9. If Apu makes a profit of \$15 on each Rider and \$30 on each Rover, write an expression to represent the total profit he receives. Let x represent the number of Riders he sells, and let y represent the number of Rover he sells.

Total Profit = _____

This function is known as an *objective function*. The objective function is the function that you are trying to maximize or minimize. (In this case, the objective is to maximize Apu’s profit.)

10. Apu makes a profit of \$15 for each Rider and \$30 for each Rover.

a. Find three ordered pairs in which the total profit earned would be \$90, \$120, or \$180. (The points you select do not have to be in the feasible region.)

PROFIT	ORDERED PAIRS		
\$90	(__ , __)	(__ , __)	(__ , __)
\$120	(__ , __)	(__ , __)	(__ , __)
\$180	(__ , __)	(__ , __)	(__ , __)

- b. On the grid below, plot each set of points (those for a total profit of \$90, those for a total profit of \$120, and those for a total profit of \$180) in a different color. Each set of three points should form a straight line. Why does this make sense?

Draw a line through each set of points. What do you notice about these lines? Why does this make sense?

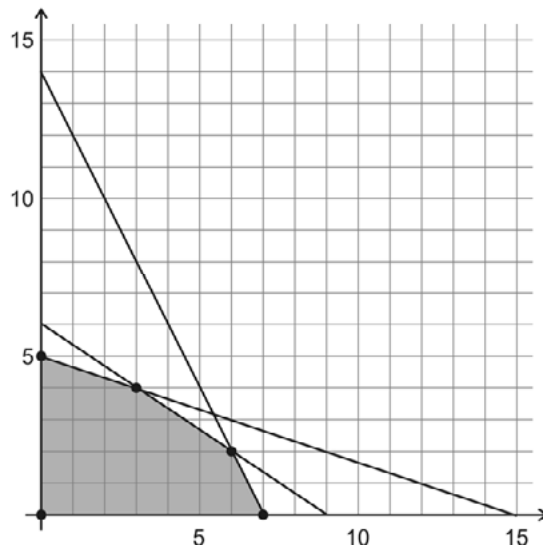

- c. Does one of these values — \$90, \$120, or \$180 — represent the MAXIMUM total profit that Apu can earn if he receives a profit of \$15 for each Rider and \$30 for each Rover? Explain your reasoning.

11. Using the TI-83+ or TI-84+ Graphing Calculator, follow the steps outlined below.

- a. Press **PRGM**. Use the down cursor key to highlight **DRTBK**. Press **ENTER**. Press **STAT**. Press **ENTER**.
- b. Use the up cursor key to highlight **L1**. Press **2nd** **DEL**. Press **2nd** **STAT**. Use the down cursor key to highlight **RIDER**. Press **ENTER** twice. This column represents the number of Riders sold.
- c. Use the right and up cursor key to highlight **L1**. Press **2nd** **DEL**. Press **2nd** **STAT**. Use the down cursor key to highlight **ROVER**. Press **ENTER** twice. This column represents the corresponding number of Rovers sold.
- d. Use the right and up cursor key to highlight **L1**. Press **2nd** **DEL**. Press **2nd** **STAT**. Use the down cursor key to highlight **TPRFT**. Press **ENTER** twice. This column represents the Total Profit received.
- e. Use the right and up cursor key to highlight **L1**. Press **2nd** **DEL**. Press **2nd** **STAT**. Use the down cursor key to highlight **PRFIT**. Press **ENTER** twice. The first number in this column represents the profit earned for each Rider sold and the second number represents the profit earned for each Rover sold.
- f. Use the up cursor key to highlight the number below **PRFIT**. Type in a value for the profit Apu receives for each Rider he assembles. Press **ENTER**. Type in a value for the profit Apu receives for each Rover he assembles. Press **ENTER**.

In **Step f**, enter 15 as the profit for each Rider and 30 as the profit for each Rover. Move the cursor to the **TPRFT** column. Use the cursor key to find the *maximum total profit* (the largest number in this column).

Record this value in the appropriate space in the table below. Along with this value, record the corresponding values for Riders and Rovers. To change the profit earned on each Rider and Rover, move to the **PRFIT** column and repeat **Step f**. Complete the table below choosing your own values for the last several rows.

PROFIT ON EACH RIDER	PROFIT ON EACH ROVER	NUMBER OF RIDERS	NUMBER OF ROVERS	MAXIMUM TOTAL PROFIT
\$15	\$30			
\$20	\$20			
\$10	\$40			

Compare your results with those of your team members. Which combinations of **(Rider, Rover)** always appear?

Where are these points located on your graph in Question 6?

Given all the points in the feasible region, why do you think that just one **(Rider, Rover)** combination always yields the maximum profit?

12. Using your graphing calculator, follow the steps below.

Step 1: Press **APPS**. Press the up cursor key. Use the down cursor key to highlight **TRANSFRM**. Press **ENTER** twice.

Step 2: Press **WINDOW**. Press the up cursor key. Use the down cursor key to highlight step. Type in 5. Press **ENTER**. Press **GRAPH**.

Step 3: Use the up or down cursor key to move to **A**. Enter **15**. Press **ENTER**. **A** represents the profit earned for each Rider. Use the down cursor key to move to **B**. Enter **30**. **B** represents the profit earned for each Rover. Press **ENTER**. Use the down cursor to move to **C**. Type in **0**. Press **ENTER**. **C** represents the total profit earned.

Step 4: Use the right cursor key to increase the value of **C**. Watch the line on your graph.

a. As the line moves, what is the last point in the feasible region through which the line passes?

(_____ , _____)

b. What is the value of **C** at this point? _____

c. Repeat **Steps 3** and **4** for different values of **A** and **B**. As a team, come up with an explanation for why the corner points of the feasible region always yield the maximum (or minimum) profit.



13. Let's return to Apu's dilemma.

Apu sets his prices so that he will make a profit of \$21 for every Rider he sells and \$32 for every Rover he sells. Determine *algebraically* how many of each type he should assemble to receive the maximum profit. What is the maximum profit?

14. Look over your responses to Questions 4-12. Concentrate on the process needed to solve Apu's dilemma. Assume that you do not have access to a graphing calculator. As a team, discuss and list **five** major steps required to solve a problem of this type (which is known as a *linear programming problem*).

15. Use your steps from Question 14 to solve the problem below.

Lisa is making cookies to sell at the Annual Dirt Bike Competition. A dozen oatmeal cookies require 3 cups of flour and 2 eggs. A dozen sugar cookies require 4 cups of flour and 1 egg. She has 40 cups of flour and 20 eggs. She can make no more than 9 dozen oatmeal cookies and no more than 7 dozen sugar cookies, and she earns \$3 for each dozen oatmeal cookies and \$2 for each dozen sugar cookies. How many dozens of each type of cookie should she make to maximize her profit?

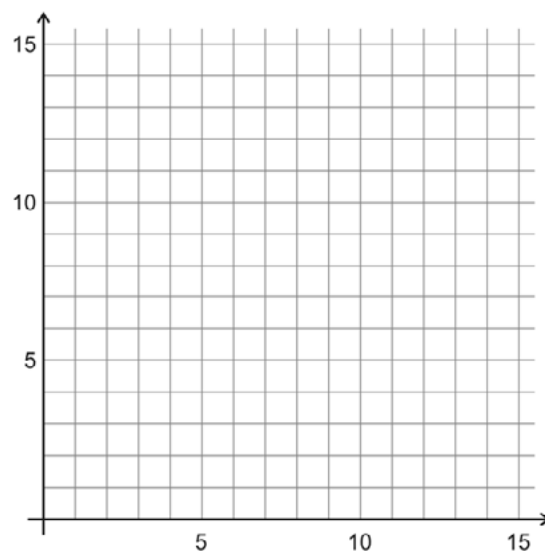

Task #20: Jackson's Party

Jackson is buying wings and hot dogs for a party. Hotdogs cost \$4 per pound and a package of wings costs \$7. He has at most \$56 to spend on meat. Jackson knows that he will buy at least five pounds of hot dogs and at least two packages of wings. List and justify at least two solutions for the number of packages of wings and pounds of hot dogs Jackson could buy.

SREB Readiness Courses
Transitioning to college and careers

College Readiness Mathematics

Unit 6 . Quadratic Functions
Student Manual
Version 3

Name



Unit 6 . Quadratic Functions

Table of Contents

Lesson 1.....	4
Lesson 2.....	5
Lesson 3.....	9
Lesson 5.....	19
Lesson 6.....	23
Lesson 7.....	34
Lesson 8.....	36
Lesson 9.....	43
Lesson 10.....	44
Lesson 11.....	47
Lesson 12.....	50

Task #1: Quadratic or Not?

In your groups, use the illustration to help you in defining key features of quadratic graphs. Prepare a toolkit to share with the class.

1. The following are graphs of quadratic functions:

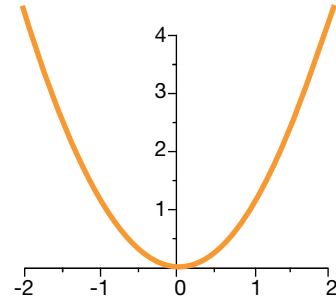
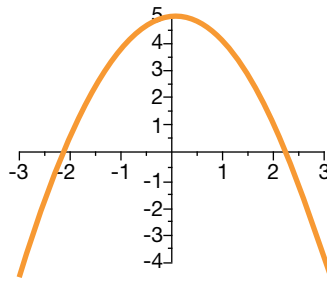
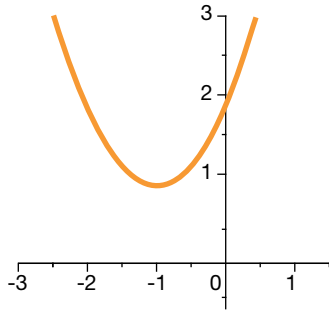

2. The following are not graphs of quadratic functions:

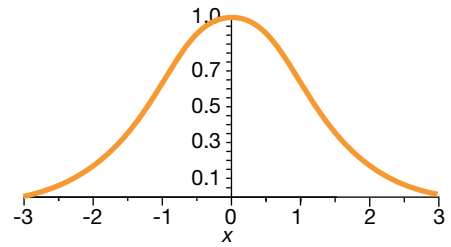
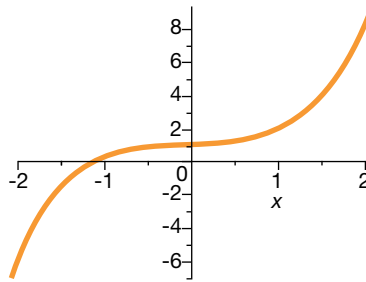
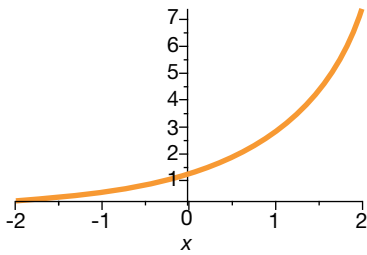

Describe how quadratics differ from functions that are not quadratics. Describe any symmetries that you see, asymptotes, the domain, range, how it is decreasing or increasing, concavity.

Quadratics

Job Descriptor Cards

Reading Manager

- Reads ALL parts of the assignment and problems out loud to the group (others follow along).
- Ensures group members understand assignments.
- Keeps group focused on the task(s).

Spying Monitor

- Monitors group progress relative to other groups.
- Checks in with other groups for comparison.
- Only member in group that can talk/ask questions outside of group.

Quality Controller

- Ensures that all group members can EXPLAIN and JUSTIFY each response (random checks occur by management).
- Makes sure members are completing ALL problems in appropriate notebook.
- Keeps group supplies organized and neat.
- Reports missing items.

Recording Time Keeper

- Keeps track of time.
- When asked, shares group responses.
- Responsible for ensuring “public record” (posting of answers, group posters, etc.) is completed.

Task #2: The effect of a, b, and c

Answer the following equations for each function set. Each function set has four equations to explore.

Function Set 1

Equation 1: $f(x) = x^2 + 2x - 3$

Equation 2: $f(x) = -x^2 + 2x - 3$

Equation 3: $f(x) = 3x^2 + 2x - 3$

Equation 4: $f(x) = -3x^2 + 2x - 3$

What is different between equations 1 and 2?

What is different between equations 1 and 3?

What is different between equations 2 and 4?

What is different between equations 3 and 4?

What is the domain of the first function?

What is the domain of the second function?

What is the domain of the third function?

What is the domain of the fourth function?

Function Set 2

Equation 1: $f(x) = x^2 + 2x - 3$

Equation 2: $f(x) = -x^2 + 2x + 3$

Equation 3: $f(x) = x^2 + 2x + 3$

Equation 4: $f(x) = -x^2 + 2x - 3$

What is different between equations 1 and 2?

What is different between equations 1 and 3?

What is different between equations 2 and 4?

What is different between equations 3 and 4?

What is the domain of the first function?

What is the domain of the second function?

What is the domain of the third function?

What is the domain of the fourth function?

Function Set 3

Equation 1: $f(x) = x^2 + 2x - 3$

Equation 2: $f(x) = x^2 - 2x - 3$

Equation 3: $f(x) = 3x^2 + 2x - 3$

Equation 4: $f(x) = 3x^2 - 2x - 3$

What is different between equations 1 and 2?

What is different between equations 1 and 3?

What is different between equations 2 and 4?

What is different between equations 3 and 4?

What is the domain of the first function?

What is the domain of the second function?

What is the domain of the third function?

What is the domain of the fourth function?

Function Set 4

Equation 1: $f(x) = x^2 + 2x - 3$

Equation 2: $f(x) = 5x^2 + 2x + 5$

Equation 3: $f(x) = 3x^2 + 2x - 3$

Equation 4: $f(x) = -9x^2 + 2x + 4$

What is different between equations 1 and 2?

What is different between equations 1 and 3?

What is different between equations 2 and 4?

What is different between equations 3 and 4?

What is the domain of the first function?

What is the domain of the second function?

What is the domain of the third function?

What is the domain of the fourth function?

Task #3 Egg Launch Contest

Egg Launch Contest

NAME: _____

DATE: _____

Mr. Rhodes’ class is holding an egg launching contest on the football field. Teams of students have built catapults that will hurl an egg down the field. Ms. Monroe’s class will judge the contest. They have various tools and ideas for measuring each launch and how to determine which team wins.

Team A used their catapult and hurled an egg down the football field. Students used a motion detector to collect data while the egg was in the air. They came up with the table of data below.

DISTANCE FROM THE GOAL LINE (IN FEET)	HEIGHT (IN FEET)
7	19
12	90
14	101
19	90
21	55
24	0

Team B’s egg flew through the air and landed down the field. The group of students tracking the path of the egg determined that the equation $y = -0.8x^2 + 19x - 40$ represents the path the egg took through the air, where x is the distance from the goal line and y is the height of the egg from the ground. (Both measures are in feet.)

When **Team C** launched an egg with their catapult, some of the judges found that the graph to the right shows the path of the egg.

Which team do you think won the contest? Why?

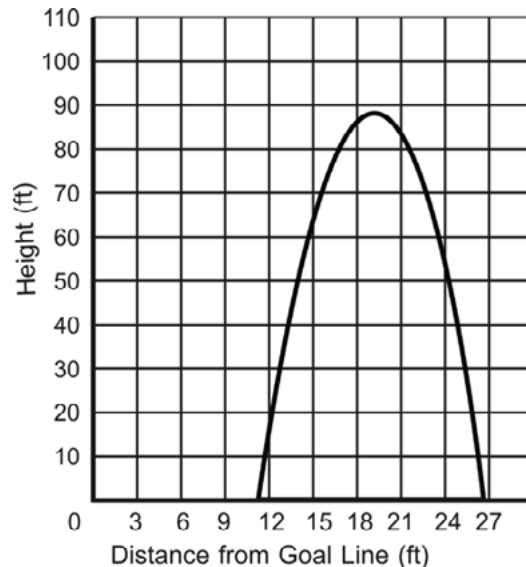

Team A

- Using the data from Team A, determine an equation that describes the path of the egg. Describe how you found your equation.
- On the graph below, graph the path of Team A’s egg.
- What is the maximum height that the egg reached? How far was the egg hurled?

Team B

- Using the equation from Team B, generate a table of values that shows different locations of the egg as it flew through the air.

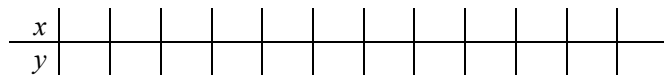

- On the graph below, graph the path of Team B’s egg.
- What is the maximum height that the egg reached? How far was the egg hurled?

Team C

- Using the data from Team C, generate a table of values that shows different locations of the egg as it flew through the air.

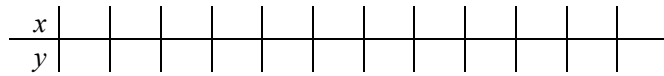

- On the graph below, re-graph the path of Team C’s egg.
- What is the maximum height that the egg reached? How far was the egg hurled?

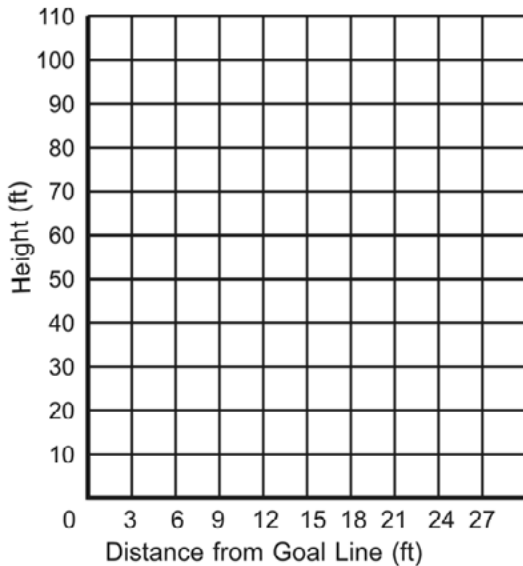

- If it is a height contest, which team wins? How do you know?
- If it is a distance contest, which team wins? How do you know?
- Find a method of determining a winner so that the team that did not win in Question 10 or Question 11 would win using your method.

Task #4: Tell an Egg-celent Story



Task #5: Making Sense of the Three Forms of Quadratic Functions

Often times the standard form of a quadratic is used in projectile motion. For this particular situation, the equation $h(t) = -\frac{1}{2}gt^2 + v_0t + h_0$ gives the height of an object at time t for an object that has initial velocity, v_0 and initial height of h_0 . “ g ” is a gravitational constant and is either $9.8m/s^2$ or $32ft/s^2$. Often times a simpler form of the equations look like:

For Meters - $h(t) = -9.8t^2 + v_0t + h_0$

For Feet - $h(t) = -16t^2 + v_0t + h_0$

1. A piece of paper and a hammer are dropped off the top of your school which is 90 feet high. They are both dropped from a still position (that is $v_0=0$ for both). If we ignore air resistance, which object, the paper or hammer, hits the ground first? Provide a mathematical argument that starts by sketching a picture of the graph and concludes with an analysis of the equation.

2. A potato is fired from a spud-gun at a height of 3m and an initial velocity of 25m/s, write the equation of this potato projectile. How high does the potato reach and at what time does this occur?

3. Two competing catapults launch pumpkins. Catapult A launches from a starting height of 10ft and an initial upward velocity of 45ft/sec. Catapult B launches from a starting height of 25ft and an initial upward velocity of 40ft/sec. Which pumpkin, A or B, achieves a greater maximum height?

Which pumpkin, A or B, is in the air longer?

Is it possible from this scenario to determine the distance traveled horizontally by each pumpkin? Explain your choices and justify your answers.

4. The Angry Birds Screen shot shows two flight paths of two different birds. Using a straight edge, construct a coordinate axes where the center of the slingshot is at the origin. Carefully assign point values to the two parabolas and write an equation for each. Show which points you used and which form of the equation you found most helpful.



Using mathematical analysis and your equations do the two birds hit at the same spot? Why or why not?

5. The points used to model a parabola are $(-3, 0)$, $(6, 0)$ and $(4, -5)$. Write an equation for this parabola. Which form is most helpful and why?

6. The vertex of a parabola is $(15, -30)$ and the y-intercept is $(0, 25)$. Is this enough information to write the equation? If so, do such, if not explain.

Task #6: Linear or Quadratic

Based on our work in this lesson and your work in the linear unit (Unit 3) explain in words the differences in LINEAR and QUADRATIC equations.

How is the structure of the equations different?

How is it similar? Are there similar techniques/processes, if so what?

Task #7: Skeleton Tower

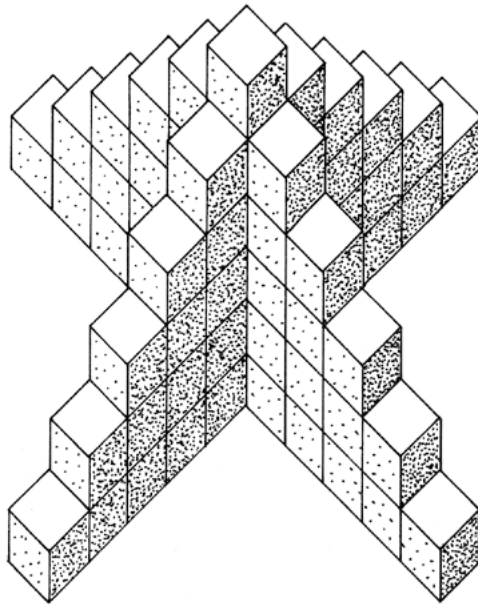

1. How many cubes are needed to build this tower?

Show your calculations

2. How many cubes are needed to build a tower like this, but 12 cubes high?

Explain how you figure out your answer.

3. How would you calculate the number of cubes needed for a tower n cubes high?

Task #8: Project Planning – Flight of the Gummy Bears

If our goal was to hit a target y -feet away, what would we need to know, what measurements would we need to record, what is our plan? How could we convince the class, using correct mathematical reasoning, that our projectile did indeed travel the furthest horizontally?

If our goal was to shoot the projectile the highest, what would we need to know, what measurements would we need to record, what is our plan? How could we convince the class, using correct mathematical reasoning that our projectile was indeed the highest?

Blank Targets

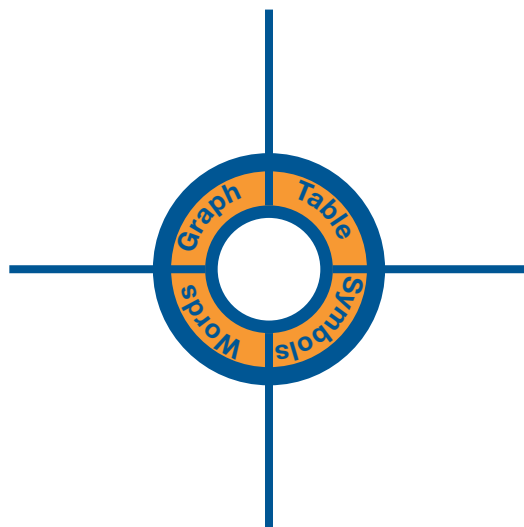
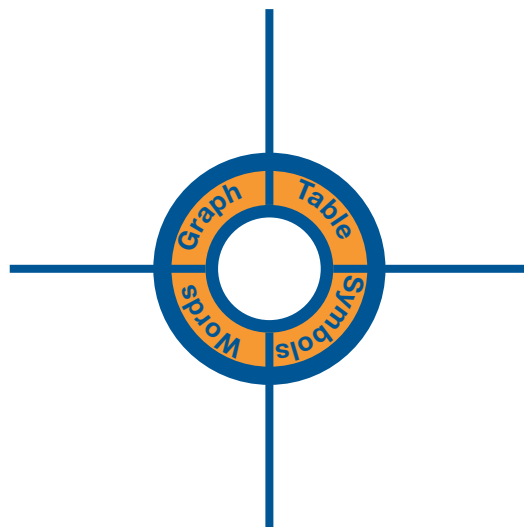
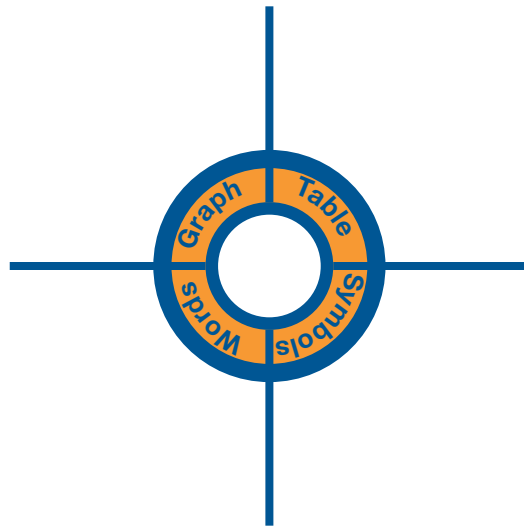

Task #9: The Same Yet Different

The purpose of this set of questions is to use the FORM to answer questions or to perhaps write the form to answer questions. You may only use a calculator for basic computational facts.

1. Suppose $h(t) = -5t^2 + 10t + 3$ is an expression giving the height of a diver above the water (in meters), t seconds after the diver leaves the springboard.

(a) How high above the water is the springboard? Explain how you know.

(b) When does the diver hit the water? Can you do this without a graphic calculator?

(c) At what time on the diver's descent toward the water is the diver again at the same height as the springboard?

(d) When does the diver reach the peak of the dive? *(You don't know how to do vertex form yet, but the idea that the vertex occurs half way between the x-intercepts should be encouraged as a method for solving.)*

2. A ball thrown vertically upward at a speed of v ft/sec rises a distance d feet in t , given by $d = 6 + vt - 16t^2$. Write an equation whose solution is:

(a) The time it takes a ball thrown at a speed of 88 ft/sec to rise 20 feet.

(b) The speed with which the ball must be thrown to rise 20 feet in 2 seconds.

3. A company's profit (in thousands of dollars) from an item depends on the price of the item. Three different expressions for the profit at a price of p dollars follow:

$$-2p^2 + 24p - 54$$

$$-2(p - 3)(p - 9)$$

$$-2(p - 6)^2 + 18$$

How could you convince someone that the three expressions are equivalent?

Which form is most useful for finding:

(a) The break-even prices? What are those prices, and how do you know?

(b) The profit when the price is 0? What is that profit, and what does it tell about the business situation?

(c) The price that will yield maximum profit? What is that price?

4. Coyote was chasing roadrunner, seeing no easy escape, Road Runner jumped off a cliff towering above the roaring river below. Molly mathematician was observing the chase and obtained a digital picture of this fall. Using her mathematical knowledge, Molly modeled the Road Runner’s fall with the following quadratic functions:

$$h(t) = -16t^2 + 32t + 48$$

$$h(t) = -16(t + 1)(t - 3)$$

$$h(t) = -16(t - 1)^2 + 64$$

a. Why does Molly have three equations?

b. Could you convince others that all three of these rules are mathematically equivalent?

c. Which of the rules would be most helpful in answering each of these questions? Explain.

i. What is the maximum height the Road Runner reaches and when will it occur?

ii. When would the Road Runner splash into the river?

iii. At what height was the Road Runner when he jumped off the cliff?

5. Complete the missing entries in the table. Each row represents the same quadratic function.

	Standard Form	Factored Form	Vertex Form	X-Intercepts	Y-Intercepts	Vertex
f(x)	$x^2 - 4x - 32$		$(x - 2)^2 - 36$			
g(x)		$(x - 3)(x + 6)$				
h(x)	$3x^2 - 10x - 8$					
k(x)			$(x - 2)^2 - 49$			
m(x)			$-(x+3)^2 + 25$			

Task #10: Flying Marshmallows

Launch your marshmallow out of a rolled up sheet of paper according to the directions below. Fill in all information as you go.

Outside Group Jobs:

Marshmallow Tech: _____

Timer: _____

Recorder: _____

Inside Group Jobs:

Equation Manager: _____

Graph Manager: _____

Accuracy Manager: _____

Quadratic One: Laying on your back

Have the person laying on their back launch the marshmallow. Make sure the timer keeps accurate time of how long the marshmallow is in the air. The recorder needs to record all data on this sheet.

Time Marshmallow was launched:

Height of marshmallow at launch:

Time Marshmallow landed:

Height of marshmallow at landing:

Sketch an accurate and labeled graph of the flight of your marshmallow

Show a table of the data you collected. Use the table to determine the maximum height of the marshmallow and the time at which this occurs.

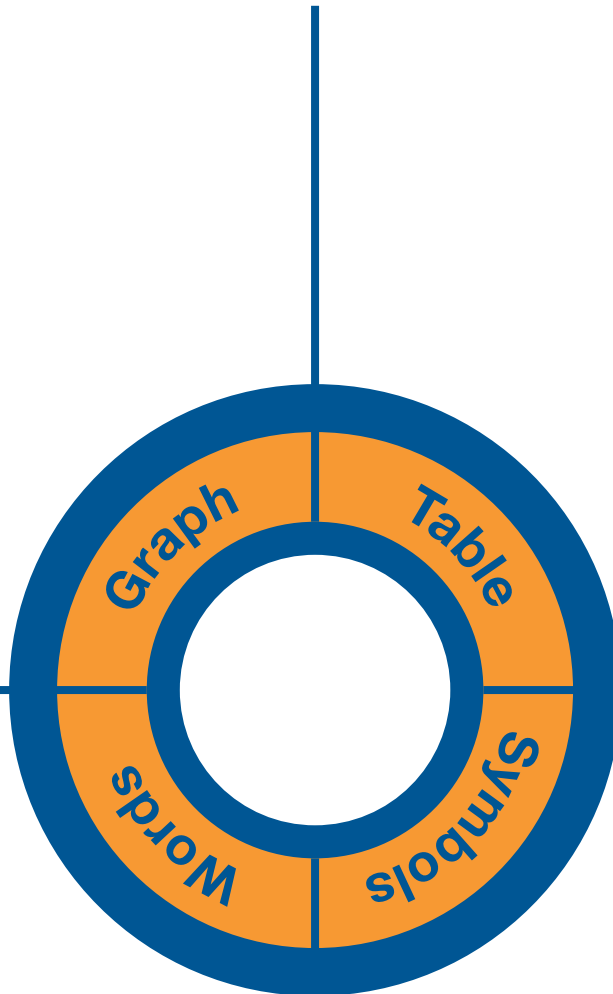

Write a description of what your marshmallow does.

Write the factored form of the flight of your marshmallow using:
 $h(t) = -16(x - t_1)(x - t_2)$

Write the equation for the flight of your marshmallow in factored form.

Write this in STANDARD FORM:

VERTEX FORM of a graph is $y = a(x - h)^2 + k$ where (h, k) is the vertex. Use this information and another point to write the VERTEX form of the function.

Task #11: Flying Marshmallows Follow-Up

Pick ONE flight path from your data to answer the following questions:

In factored form the flight of your marshmallow looks like: $h(t) = -16(x - t_1)(x - t_2)$.

- What are -16 , t_1 , and t_2 ?

- Write the equation for the flight of your marshmallow in factored form.

- Write this equation in *standard form*.

- From either of these forms, what was the maximum height your marshmallow obtained?

- When was this height obtained? Use this information, along with one of your other points to write the equation for your marshmallows flight in vertex form— $y = a(x - h)^2 + k$.

Task #12: Completing the Square

Method 1 – Algebra Tiles:

How does this algebra model tile representation illustrate the product of $(x + 4)^2$?

x^2	x	x	x	x
x	1	1	1	1
x	1	1	1	1
x	1	1	1	1
x	1	1	1	1

Let's look at an expanded form: $f(x) = x^2 + 8x + 10$

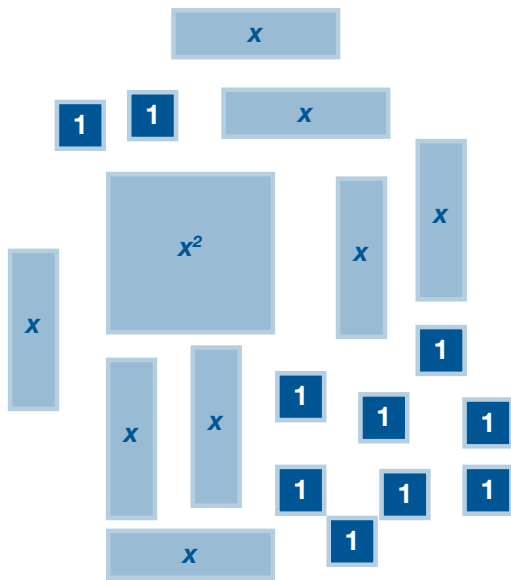

Try to arrange this set of tiles into a PERFECT SQUARE.

What problems are you running into?

What could be done to remedy this situation? If I were to allow you extra tiles, what would you need? Or would you rather take some away?

If you ignored for the time being all your “ones” how many ones would you need to make a PERFECT SQUARE?

How could we keep this net gain at zero?

The vertex form of this quadratic is $f(x) = (x + 4)^2 - 6$. Explain how this process helped me arrive at the vertex form.

Method 2 – Area Model (Algebra tiles generalized):

The squared expression $(x + 4)^2$ is represented geometrically to the right. Explain/make sense of this model.

	x	4
x	x^2	$4x$
4	$4x$	16

Let's try to reverse the process. Say I am building a PERFECT SQUARE and have the following. In each case, decide what it is I need to add on to have a completely perfect square. Draw an area model to illustrate your thought process.

a) $x^2 - 8x$

b) $x^2 - 10x$

c) $x^2 - 3x$

d) $x^2 + 14x$

e) $x^2 + 5x$

Now, what if I have $x^2 + 6x - 10$ and I would like to write it in vertex form. First I need a perfect square. Ignore the -10 and figure out what it is I need to complete my perfect square with $x^2 + 6x$.

How can you keep balance with what you have added to the problem?

Write $x^2 + 6x - 10$ in vertex form.

Task #13: Practice Vertex Form/Complete the Square

Write the following quadratics in vertex-form and give the vertex of the quadratic:

1) $f(x) = x^2 + 3x - 18$

2) $g(x) = x^2 + 2x - 120$

3) $h(x) = x^2 + 7x - 17$

4) $k(x) = x^2 + 9x + 20.25$

5) $s(x) = 4x^2 - 5x - 21$

6) $t(x) = 16x^2 + 9x + 20$

7) $f(x) = -2x^2 + 10x - 5$

8) $r(x) = -3x^2 - 5x + 2$

Practice for Lesson 6 Vertex Form/Completing the Square:

Worksheet 2: Practice for Lesson 6

1) What value is required to complete the square?

a) $x^2 + 20x + \underline{\hspace{2cm}}$ b) $x^2 - 7x + \underline{\hspace{2cm}}$ c) $x^2 - 4x + \underline{\hspace{2cm}}$

2) Convert each quadratic function to vertex form AND find the coordinates of the max/min point on its graph.

a) $a(x) = x^2 + 12x + 11$

b) $b(x) = x^2 - 4x + 7$

c) $c(x) = x^2 - 18x + 74$

d) $d(x) = x^2 - 2x - 48$

e) $g(x) = x^2 - 2x - 8$

f) $f(x) = x^2 + 12x + 20$

3) For each of the functions you may use any method you choose to record the information in the table.

Function	x-intercepts	y-intercept	Max or min?	Vertex
$a^2 - 2a - 8 = 0$				
$b^2 + 2b - 33 = 0$				
$c^2 - 8c + 21 = 6$				
$d^2 + 13d + 22 = 7$				
$f^2 + 19f + 66 = 6$				

Task #14: Extension Piper and Golden Gate Bridge

Piper, the amazing golden retriever, likes to go exploring. Aiming to keep her home more, Stefanie has decided to fence in part of her yard. She purchased 500 feet of fencing at Lowes this weekend and plans to use the back side of her house as one side of the Piper-pen. Stefanie would like to fence in the largest possible area for Piper. Find the width and length that gives Piper the largest possible yard to play in.

Use vertex form to prove that of all rectangles with a given perimeter, a square has the greatest area.

The golden gate bridge spans 4,200 feet between towers. The towers supporting the cables are 500 feet high. Suppose the middle of the bridge is $(0,0)$. Write a function in vertex form to model the support cables on the Golden Gate Bridge. How high is the cable in the middle of the bridge?

Task #15: Conic Flyer

Describe in general terms how each parameter (slider) changes the graph:

(a) Purple

(b) Red

(c) Blue

1. Which of these parameters affects the range of each parabolic function? Explain.

2. The equation $y = 1(x - 0)^2 + 0$ or $y = x^2$ is considered the “parent” function for a vertical parabola. Find five points on the graph of $y = x^2$ and list them below.

3. Fold a sheet of graph paper into fourths, and draw a pair of y- and x- axes in each. Use your five values to graph $y = x^2$. in each fourth of the sheet. First predict how the graph of $y = x^2$ would change for each of the following and then sketch each on the graph paper (without substituting any points for the new equations below).

(a) $y = (x - 2)^2 + 4$

(b) $y = -(x + 3)^2 - 1$

(c) $y = 3(x + 1)^2 - 2$

(d) $y = -\frac{1}{3}(x + 1)^2 - 2$

4. Determine the range of each function above.

Task #16: Solving Quadratics

Using any method you choose, solve the following equations.

1. $3x + 7 = 5$

2. $3x^2 - 5 = 7$

3. $x^2 + 42x - 9 = 0$

4. $3x^2 + 15x - 6 = 0$

Task #17: Angry Birds

An angry bird's flight path is given by the equation $h(t) = 45 + 25t - 16t^2$. As a group, use this information and construct viable arguments for the following claims.

Are pigs at heights of 45, 57, and 65 hit or not?

If we can hit the pigs, determine how long it will take to hit each one?

Can all three pigs be hit on the same trajectory? Explain?

In the game of angry birds, you can't control the height of the slingshot or the effect of gravity, but you can change how far back and to what angle you pull on the slingshot to fire the bird. This manipulation would directly affect the initial velocity of the bird. In our original equation the velocity was 25. If you did not hit one of the pigs at 45, 57, or 65, manipulate the value of b (to signify changing the slingshot fire) to see if you could hit one of the pigs. Provide a justified conclusion of your findings.

Task #18: Two Squares

Solve the quadratic equation using as many different methods as possible.

$$x^2 = (2x - 9)^2$$

Task #19: Solving Quadratics with tables and graphs

Some highway patrol officers use the formula $d = 0.05s^2 + 1.1s$ to predict (or sometimes analyze) stopping distance, d , for speeds, s . For the following equations, find the solution and explain what each says about stopping distance.

a) $180 = 0.05s^2 + 1.1s$

b) $95 = 0.05s^2 + 1.1s$

c) $d = 0.05(45)^2 + 1.1(45)$

d) $d = 0.05(60)^2 + 1.1(60)$

The height of a football, in feet, kicked from the ground at time, t , in seconds, can be estimated by the equation $h(t) = 35t - 16t^2$.

a. Write and solve an equation to show when the football hits the ground at the end of its flight.

b. Regulation for high school, NCAA and the NFL require the goal post to be 10 feet above the ground. At what times is the ball 10 feet or higher above the ground? Show your work.

Task #20: Solving Quadratic Functions with tables and graphs

Show all work to make sure others can follow your approach.

1. $3(x - 4)^2 - 2 = 25$

2. $(6x + 5)(2x - 1) = 0$

3. $9x^2 + 4.7x - 6 = 0$

Task #21: Evaluating Others Thinking Quiz

Three students, Jerome, Chelsey, and Travis, were asked to solve the following quadratic equation:

$$x^2 + 4x - 11 = 10$$

They have shared their processes of solving this problem with you below:



Factoring is easy, bro'. Therefore, I started this equation by first moving the 10 to set the equation equal to zero. (Because before you factor it has to be equal to zero.)

Then I looked at factors of -21 that added to 4. I came up with -3 and 7. So my equation now looks like this:

$$(x-3)(x+7)=0$$

By the zero product property, I know in order for the product to be zero, one of the factors must be zero. Therefore $x-3 = 0$ is one answer which gives me $x=3$ AND $x+7=0$ is another answer which gives me $x=-7$. My final answers $x=-7$ and 3.

Graphing is MONEY! It's so easy—all you have to do is press a few buttons and it's done. But first you have to get the equation to one side, so I subtracted 10 from both sides to get:

$$x^2 + 4x - 21 = 0$$

Then I put this in Y1 of my calculator and pressed graph. I noticed that this parabola crosses the x-axis twice and the y-axis once. Then I went to my table and got confused. I saw zero three times in different places. When $x=3$, -7 and when $y=-21$. So I guess there are three answers: -21 , -7 , and 3. But I am not sure?



I really need to work on completing the square. I get some of the ideas but need practice so I tried this problem by completing the square. To start I got everything to one side. Then I regrouped my terms and left spaces for the "little square" (ones) I was going to add in. I figured out that I needed 4 to "complete my square", so I added 4 and subtracted 4 to keep balance. So now I have

$$(x^2 + 4x + 4) - 21 - 4 = 0$$

I simplified this to . Then I started to solve by adding 25 to both sides to get $(x + 2)^2 - 25 = 0$. Now take the square root of both sides to get $x+2=5$ and $x+2=-5$. Solving both of these gives me AND so my two answers are 3 and -7.

Evaluate Others Thinking Quiz

What do Jerome's, Travis's and Chelsey's methods have in common?

Are the three students correct in their reasoning?

Travis seems to be confused. Provide an explanation (can include words and pictures) to clear up Travis' confusion.

Will all three methods always work? Why or why not? Explain.

Using the method of your choice, solve the following quadratic. $x^2 - 4x - 90 = 0$
Indicate whose method you choose and WHY.

Task #22: Formative Assessment/Introductory Activities

1. Draw, if possible, a quadratic function that has:

a. zero roots

b. one root

c. two roots

d. three roots

2. Solve $2(x + 3)^2 - 5 = 0$ without a calculator.

3. Solve $2x^2 + 12x - 13 = 0$ without a calculator. (If you can't do this, don't worry. We will get to it in this lesson but give it a try.)

Task #23: Completing the Square to Quadratic Formula

The main body of the lesson:

Consider again $2x^2 + 12x - 13 = 0$. We will review how, using the clever completing the square trick, we can change the form of this equation to make it easier to solve.

- (a) Complete the missing step below:

$$\text{Note that } 2x^2 + 12x - 13 = 2(x^2 + \underline{\hspace{2cm}}) - 13$$

- (b) Which of the following choices is equal to $2(x^2 + 6x) - 13$

(i) $2(x^2 + 6x + 9) - 13$ (ii) $2(x^2 + 6x + 9) - 4$

(iii) $2(x^2 + 6x + 9) - 22$ (iv) $2(x^2 + 6x + 9) - 5$

- (c) Since $x^2 + 6x + 9 = (x + 3)^2$, use your answers to (a) and (b) above to complete the following sentence:

$$2x^2 + 12x - 13 = \underline{\hspace{2cm}} (x + 3)^2 - \underline{\hspace{2cm}}$$

- (d) Use your answer to (c) to solve $2x^2 + 12x - 13 = 0$ (Hint: you already did this)

We will now do something similar to develop the important and powerful Quadratic Formula, a formula that allows us to solve EVERY quadratic equation.

Suppose we need to solve the equation $ax^2 + bx + c = 0$ for x .

- (a) Complete the missing step below:

$$\text{Note that } ax^2 + bx + c = a(x^2 + \underline{\hspace{2cm}}) + c$$

- (b) Complete the missing step below:

$$a(x^2 + \frac{b}{a}x) + c = a(x^2 + \frac{b}{a}x + \frac{b^2}{4a^2}) + \underline{\hspace{2cm}}$$

- (c) Factor $x^2 + \frac{b}{a}x + \frac{b^2}{4a^2}$

- (d) Use your answers to (a), (b) and (c) above to complete the following sentence:

$$ax^2 + bx + c = a(x + \underline{\hspace{2cm}})^2 - \underline{\hspace{2cm}}$$

- (e) Use your answer to (d) to solve the equation $ax^2 + bx + c = 0$
(Hint: think about what you did to solve $2(x + 3)^2 - 5 = 0$).

Explain why the part of the formula $b^2 - 4ac$ (called the discriminant) tells you—without graphing—how many real roots the quadratic equation will have.

The Quadratic Formula

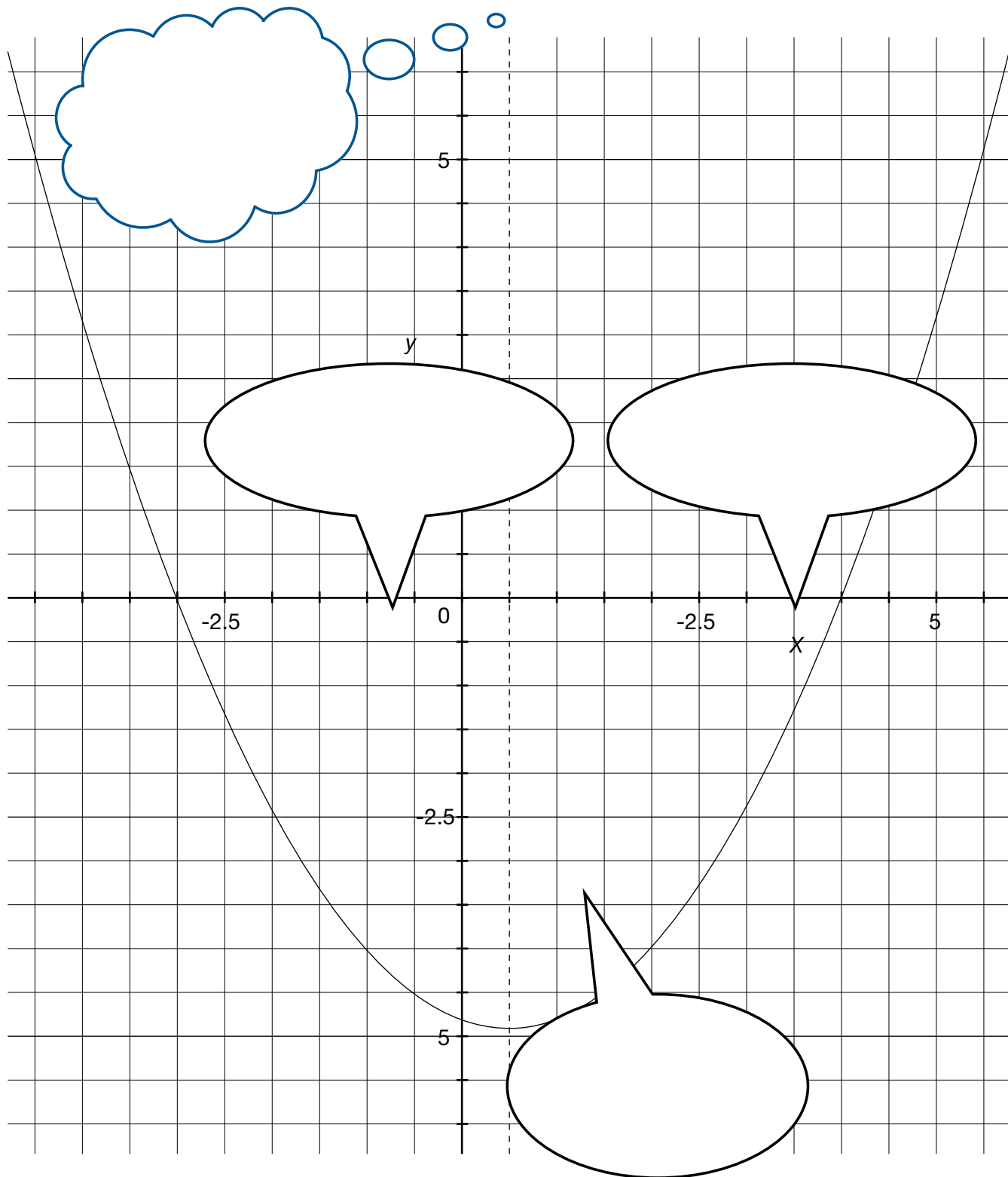

Task #24: Rockets

Rockets were assembled from kits by members of an engineering club and were launched from the ground at the same time. The height y in feet of one rocket after t seconds is given by $y = -16t^2 + 150t + 5$. The height of the other rocket is given by $y = -16t^2 + 160t$. After how many seconds are the rockets at the same height? What is this height?

Task #25: Practice Problems Non-Linear Systems

For each system below:

- a) Graph each system by hand. If an equation is linear, rewrite it in slope-intercept form first and use this to help graph the line. If an equation is quadratic, rewrite it in vertex form and use this to help graph the parabola. Show your work next to each graph.
- b) Verify your results with a graphing utility.

$$1) \begin{cases} y = x^2 + 1 \\ y = 4x + 1 \end{cases}$$

$$2) \begin{cases} y - x = -1 \\ y = x^2 - 6x + 9 \end{cases}$$

$$3) \begin{cases} 3x - y = -2 \\ 2x^2 - y = 0 \end{cases}$$

$$4) \begin{cases} y = -1 \\ y = -2x^2 + 4x - 5 \end{cases}$$

Task #26: Gummy Bear Shoot Off

Using a tongue depressor, rubber band and a gummy bear you will devise a contraption to “fire” your gummy bear. The object of this project is not in the design of your firing device but rather your mathematical analysis of the flight of your gummy bear. This competition is similar to the egg launch we looked at in Lesson 3. In fact, you may wish to reference the brainstorming ideas from that lesson.

You are to fire your gummy bear and collect all necessary data. As a group, you will prepare one report that must include careful mathematical analysis of your gummy bear including equations, graphs, tables and descriptions. Write AND answer questions about the flight of your gummy bear.

Your final project will be graded according to the rubric and evaluated for mathematical correctness and completion.

In your report include reflections on the following questions:

- Synthesize what you have learned in this unit. How did you incorporate those ideas into your mathematical analysis of your gummy bear?
- How do the different forms of a quadratic reveal different information about the flight of your gummy bear? In answering questions?

Topic	Not Yet	Getting There	Proficient	Highly Proficient
Tables and Graphs	Tables and graphs are missing or incomplete	Tables and graphs are present but contain mechanical flaws	Tables and graphs are present and correct	Tables and graphs are present and correct and are discussed and/or connected in other areas of the analysis.
Equations	Equations are incorrectly calculated	Equations show signs of correct thinking but flaws are present (in procedure or understanding)	Equations are correct and all work is shown how they were developed.	Equations are thorough and correct and connected to other areas of the analysis.
Analysis of Mathematics	Mathematical analysis contains flaws in conceptual understanding. Tables, graphs and equations are presented as three separate pieces and not tied together.	Mathematical analysis has gaps in understanding. Demonstrates a basic understanding but does not comprehend the interplay of tables, graphs, and equations.	Demonstrates understanding of the interplay of tables, graphs, and equations and can accurately describe the scenario in terms of all.	Exceeds proficient and demonstrates a solid foundation in analyzing a mathematical situation from all standpoints.
Questions in Regard to Flight	Ask two or fewer questions that are relevant and make sense to the data collected	Ask three questions but may not be relevant or make sense to the data	Ask three “good” questions that make sense to ask and are relevant to data	Ask in-depth questions that demonstrate a complex understanding of the concepts. Questions are well thought out and relevant.
Answers to Questions Asked	Did not answer questions correctly	Answered questions but incorrect thinking or contains mathematical flaws OR did not provide justification of answers (bald answers)	Answered questions correctly and provides justification	Answers are well documented and supported and display an in-depth understanding of the concept
Synthesis of Unit as a Whole	Project does not show overall mathematical understanding. Significant gaps in mathematics.	Project shows some understanding of math but disjointed. Information is spotty and incomplete	Project displays a cohesive, comprehensive understanding of quadratic functions. Ideas are connected and there are no mathematical flaws.	Project goes above and beyond and shows an in-depth complex understanding of analyzing quadratic functions.
Overall Cohesiveness of Project	Project is disjointed and put together in pieces	Some areas of project are disjointed – lacks clarity and/or focus	Project feels as “one” project. Pieces fit together and flow	Project is cohesive and complex and answers all questions in a non-list rather, comprehensive, manner

SREB Readiness Courses
Transitioning to college and careers

College Readiness Mathematics

Unit 7 . Exponential Functions
Student Manual
Version 3

Name



Unit 7 . Exponential Functions

Table of Contents

Lesson 1.....	3
Lesson 2.....	7
Lesson 3.....	14
Lesson 5.....	18
Lesson 6.....	20

Task #2: Linear or Exponential?

1. In (a)–(e), say whether the quantity is changing in a linear or exponential fashion.

a. A savings account, which earns no interest, receives a deposit of \$723 per month.

b. The value of a machine depreciates by 17% per year.

c. Every week, $\frac{9}{10}$ of a radioactive substance remains from the beginning of the week.

d. A liter of water evaporates from a swimming pool every day.

e. Every 124 minutes, $\frac{1}{2}$ of a drug dosage remains in the body.

(Source: Illustrative Mathematics)

2. The functions below represent exponential growth or decay. What is the initial quantity? What is the growth rate? Is this growth or decay and how do you know? Make a rough sketch of the graph of the function and write a story problem to go with each equation.

a. $P=8(1.23)^t$

b. $Q=3.1(0.78)^t$

c. $y=3^{t/2}$

d. $w = \left(\frac{3}{2}\right)^t$

e. $P=10(3)^{t/2}$

Task #4: Ponzi Pyramid Schemes

Max has received this email. It describes a scheme for making money.

From: A Crook

Date: Thursday 15th January 2009

To: B Careful

Subject: Get rich quick!

Dear friend,

Do you want to get rich quick? Just follow the instructions carefully below and you may never need to work again:

1. At the bottom of this email there are 8 names and addresses.
Send \$5 to the name at the top of this list.
2. Delete that name and add your own name and address at the bottom of the list.
3. Send this email to 5 new friends.

If that process goes as planned, how much money would be sent to Max? Show your calculations.

“Ponzi” Pyramid Schemes: (continued)

2. What could possibly go wrong? Explain your answer clearly.

3. Why do they make Ponzi schemes like this illegal?

Task #6: Facebook Users

The number of Facebook users worldwide reached one billion on October 4, 2012. Behind India and China, Facebook would be the third largest country in the world (larger than the US!) On April 24, 2012 there were 800 million Facebook users worldwide. Find a formula for the total number of Facebook users, N (in billions of users), t days after Jan 1, 2012. This means January 1 is $t = 0$, January 2 is $t = 1$, ..., and December 31 is $t=365$. (Note 2012 was a leap year which is why December 31 is $t = 365$. In a non-leap year December 31 is $t = 364$).

Task #7: Forms of Exponential Expressions

Four physicists describe the amount of a radioactive substance, Q in grams, left after t years:

- $Q = 300e^{-0.0577t}$

- $Q = 300\left(\frac{1}{2}\right)^{t/12}$

- $Q = 300 \times 0.9439^t$

- $Q = 252.290 \times (0.9439)^{t-3}$

- a. Show that the expressions describing the radioactive substance are all equivalent (using appropriate rounding).

- b. What aspect of the decay of the substance does each of the formulas highlight

(<http://www.illustrativemathematics.org/illustrations/1305>)

(Source: Illustrative Mathematics)

Task #8: Exponential Functions

The figure to the right shows the graphs of the exponential functions $f(x) = c \cdot 3^x$ and $g(x) = d \cdot 2^x$, for some numbers $c > 0$ and $d > 0$.

They intersect at the point (p, q) .

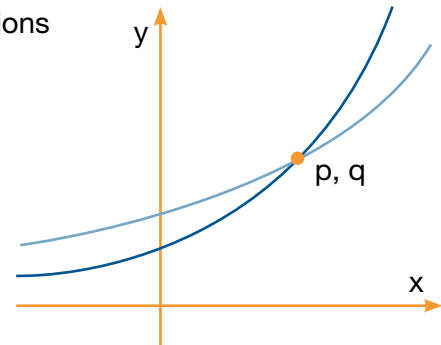

- a. Which is greater, c or d ? Explain how you know.

- b. Imagine you place the tip of your pencil at (p, q) and trace the graph of g out to the point with x -coordinate $p + 2$. Imagine I do the same on the graph of f . What will be the ratio of the y -coordinate of my ending point to the y -coordinate of yours?

(Source: Illustrative Mathematics)

Task #10: Buying a Car

You wish to purchase a certain car. Two dealerships in town are selling the car for \$20,000. Both dealerships are unique in unusual finance offers. Rather than monthly payments, you are charged interest over time, yet you are expected to pay the car off (plus interest) in one lump sum payment at a date of your choosing. The dealerships don't want to deal with paper work and are really only interested in "loaning" you money with interest. However, each offers a different payment plan. You have discretion of when you want to pay off this car.

- A. No down payment needed or payments in the first year. When you do pay for the car, you will make one full payment for the car plus any interest accrued. This plan comes with a 12% interest/per year charge.
- B. No down payment needed. No fees or penalties for not making payments. Again, you will make one full payment for the car plus any interest accrued. This plan charges 1% interest per month.

As a group, decide what plan is better for your unique needs. Your presentation to your peers should include details about how much you will have to pay off at different times and how your group arrived at the decisions you made.

Task #11: Part 1: Saving for College

When you invest money in a bank account (and add interest to your balance), the same terminology and notation applies. For example, imagine parents of a newborn baby want to invest money today in order to pay for the child's college 18 years from now. They have \$10,000 of savings they wish to deposit all at once into one savings account, which they will withdraw from 18 years from now.

- A. Bank A advertises an APR of 6% with monthly compounding. (Think about how much of this interest is applied monthly.)
- B. Bank B advertises an EAR of 6%. This means 6% interest is accrued once each year.

Which bank has the better savings account? Create a model that shows what plan the parents should choose in order to save the maximum amount possible for college.

Part 2: Saving for College with the End in Mind

Imagine the parents wish to have \$150,000 in account A in 18 years, how much would they need to deposit today?

Task #12: Buying on Credit

If you charge \$500 on a credit card today, how much will the balance be in two years (assuming no additional fees) if the credit card has a 10% APR that is compounded—

- a. once a year?

- b. once a month?

- c. once a week?

If you need \$25,000 eight years from now, what is the minimum amount of money you need to deposit into a bank account that pays an annual percentage rate (APR) of 5% that is compounded—

- a. once a year?

- b. once a month?

- c. once a day?

Task #13: The Bank Account

Most savings accounts advertise an annual interest rate, but they actually compound that interest at regular intervals during the year. That means that, if you own an account, you'll be paid a portion of the interest before the year is up, and, if you keep that payment in the account, you will start earning interest on the interest you have already earned.

For example, suppose you put \$500 in a savings account that advertises 5% annual interest. If that interest is paid once per year, then your balance B after t years could be computed using the equation $B = 500(1.05)^t$, since you'll end each year with 100% + 5% of the amount you began the year with.

On the other hand, if that same interest rate is compounded monthly, then you would compute your balance after t years using the equation:

$$B = 500\left(1 + \frac{0.05}{12}\right)^{12t}$$

- a. Why does it make sense that the equation includes the term $\frac{0.05}{12}$?
That is, why are we dividing 0.05 by 12?
- b. How does this equation reflect the fact that you opened the account with \$500?
- c. What do the numbers 1 and $\frac{0.05}{12}$ represent in the expression $\left(1 + \frac{0.05}{12}\right)^{12t}$?
- d. What does the "12t" in the equation represent?

(Source: Illustrative Mathematics)

Task #15: Monthly Deposits

If the family deposits \$500 each month into this account (6% APR compounded monthly), how much money will they have in the account—

a. one month later?

b. two months later?

c. six months later?

d. 18 years later?

Task #16: Retirement Planning

1. If you want to save \$750,000 for your retirement, you invest your money in a savings account that has an APR of 5% which is compounded each month. You are 20 years old and planning to retire at age 65, how much money do you need to deposit into the savings account each month in order to reach your retirement goal at age 65?

2. You are hired as a _____ (pick your career) and are offered an annual salary of _____ (research the average salary of your chosen career). You plan to contribute 2% of your paycheck each month to into a retirement account that with an APR of 7% compounded each month.
 - a. What is your monthly paycheck before taxes (contributions to retirement funds are typically taken out of the paycheck before taxes)?

 - b. How much money will have been saved if you work for 40 years at this job?

 - c. How much would you need to contribute each month in order to have \$500,000 when you retire?

 - d. Now assume that more realistically you are offered a raise of 2.5% each year. If you contribute 2% of your paycheck each month, how much will you have saved at the time of your retirement in 40 years?

Task #17: Car Purchase Options

You have three options to buy your new car (assume all of which have a 6% annual percentage rate that is being compounded monthly):

- A. Pay the entire cost of the car on the day of purchase.
- B. Payoff the car in 71 equal payments over 72 months (no money down).
- C. Make a down payment of 20% at the time of purchase. Then payoff the remaining value in 71 equal payments over **72 months**.

SREB Readiness Courses
Transitioning to college and careers

College Readiness Mathematics

Unit 8 . Summarizing and
Interpreting Statistical Data

Student Manual
Version 3

Name



Unit 8 . Summarizing and Interpreting Statistical Data

Table of Contents

Lesson 1.....	3
Lesson 2.....	6
Lesson 3.....	11
Lesson 4.....	17
Lesson 6.....	21
Lesson 7.....	27
Lesson 8.....	31

Statistics: Summarizing and Interpreting Data

In-Class Survey

The purpose of this survey is to provide data for use during the semester. Individuals will not be identified. You may leave any answers blank.

1. Are you male or female?
2. What is your height in inches (e.g., 5'6" = 66 inches)? _____
3. Are you right or left-handed? _____
4. How many siblings do you have? _____
5. What is your birth order (1=oldest/only child, 2=second oldest, etc.)? _____
6. How many hours of exercise do you get in a typical week? _____
7. On average, how many hours of television do you watch per week? _____
8. Make up a very random four-digit number. _____
9. Which award would you rather win: Academy Award, Olympic Gold or Nobel Prize?
10. Record your pulse (beats/minute) after measuring it in class. _____
11. How many piercings (ear, nose, etc.) do you have (count each hole)? _____
12. About how many friends do you have on Facebook (zero if not on Facebook)? _____
13. How many text messages do you send in a typical day? _____
14. What is your preferred social network (Facebook, Twitter, Instagram, FourSquare, etc.)?

15. How do you commute to school? _____
16. Do you use a Mac or PC? _____
17. How many hours of sleep do you get on a typical night? _____

Task #1: Movie Dataset

Film	Lead Studio	Audience score %	Genre	Number of Theatres in US Opening Weekend	Budget (millions of dollars)
Cars 2	Pixar	56	Animation	4115	200
Dolphin Tale	Independent	81	Drama	3507	37
Green Lantern	Warner Bros	48	Action	3816	200
Harry Potter and the Deathly Hallows Part 2	Warner Bros	92	Fantasy	4375	125
Mission Impossible 4	Paramount	86	Action	3448	145
Moneyball	Columbia	89	Drama	2993	50
50/50	Independent	93	Comedy	2458	8
Apollo 18	Weinstein Company	31	Horror	3328	5
Captain America: The First Avenger	Disney	75	Action	3715	140
Contagion	Warner Bros	63	Thriller	3222	60
The Muppets	Disney	87	Comedy	3440	45
X-Men: First Class	Disney	88	Action	3641	160
Zookeeper	Happy Madison Productions	42	Comedy	3482	80

Identify the cases in the dataset.

Identify all of the variables contained in the dataset, and determine whether each variable is quantitative or categorical.

Independent Practice Questions

1. For each situation described below, what are the cases? What is the variable? Is the variable quantitative or categorical?

a. People in a city are asked whether they support increasing the driving age to 18 years old.

b. Measure how many hours a fully charged laptop battery will last.

c. The value of tips a taxi driver receives for each trip.

d. Compare the poverty rates of each country in the world.

2. The manager of a reviews sales and wants to determine whether the amount of sales is associated to the weather outside. How the data is recorded determines whether the variables are quantitative or categorical. Describe how each variable could be measured quantitatively. Describe how each variable could be measured categorically.

“The Star-Spangled Banner”

What is the average length of a word in the “Star-Spangled Banner?”

The first two verses of the “Star-Spangled Banner” are given below. Your task is to select a sample of 10 words you will use to estimate the average length of all words in the first two verses of the song. Pick words that appear to be representative of the population of all the words. Circle the 10 words you choose.

What are the lengths (number of letters) for each of the 10 words you selected?

Note: Do not count apostrophes as letters. For example, “dawn’s” is a word that has a length of five. A hyphenated word, such as star-spangled, counts as a single word.

The “Star-Spangled Banner” (first two verses)	Word	Length
O say can you see, by the dawn’s early light,	_____	_____
What so proudly we hailed at the twilight’s last gleaming,	_____	_____
Whose broad stripes and bright stars through the perilous fight,	_____	_____
Over the ramparts we watched were so gallantly streaming?	_____	_____
And the rocket’s red glare, the bombs bursting in air,	_____	_____
Gave proof through the night that our flag was still there,	_____	_____
O say does that star-spangled banner yet wave,	_____	_____
Over the land of the free and the home of the brave?	_____	_____
On the shore dimly seen through the mists of the deep,	_____	_____
Where the foe’s haughty host in dread silence reposes,	_____	_____
What is that which the breeze, over the towering steep,	_____	_____
As it fitfully blows, half conceals, half discloses?	_____	_____
Now it catches the gleam of the morning’s first beam,	_____	_____
In full glory reflected now shines in the stream,	_____	_____
This the star-spangled banner, O long may it wave	_____	_____
Over the land of the free and the home of the brave!	_____	_____

Calculate the average number of letters for the 10 words in your sample. _____

Record the average here: _____

“Star-Spangled Banner”: Sampling Revisited

Find each of the 10 words corresponding to the 10 random numbers (between one and 158) that have been assigned to you. Count the number of letters in each of these words and compute the average number of letters in the words in your sample.

O	say	can	you	see	by	the	dawn’s	early	light
1	2	3	4	5	6	7	8	9	10
What	so	proudly	we	hailed	at	the	twilight’s	last	gleaming
11	12	13	14	15	16	17	18	19	20
Whose	broad	stripes	and	bright	stars	through	the	perilous	fight
21	22	23	24	25	26	27	28	29	30
o’er	the	ramparts	we	watched	were	so	gallantly	streaming	And
31	32	33	34	35	36	37	38	39	40
the	rocket’s	red	glare	the	bombs	bursting	in	air	gave
41	42	43	44	45	46	47	48	49	50
proof	through	the	night	that	our	flag	was	still	there
51	52	53	54	55	56	57	58	59	60
O	say	does	that	star-spangled	banner	yet	wave	o’er	the
61	62	63	64	65	66	67	68	69	70
land	of	the	free	and	the	home	of	the	brave
71	72	73	74	75	76	77	78	79	80
On	the	shore	dimly	seen	through	the	mists	of	the
81	82	83	84	85	86	87	88	89	90
deep	Where	the	foe’s	haughty	host	in	dread	silence	reposes
91	92	93	94	95	96	97	98	99	100
What	is	that	which	the	breeze	o’er	the	towering	steep
101	102	103	104	105	106	107	108	109	110
As	it	fitfully	blows	half	conceals	half	discloses	Now	it
111	112	113	114	115	116	117	118	119	120
catches	the	gleam	of	the	morning’s	first	beam	In	full
121	122	123	124	125	126	127	128	129	130
glory	reflected	now	shines	in	the	stream	T’is	the	star-spangled
131	132	133	134	135	136	137	138	139	140
banner	O	long	may	it	wave	O’er	the	land	of
141	142	143	144	145	146	147	148	149	150
the	free	and	the	home	of	the	brave		
151	152	153	154	155	156	157	158		

Task #2: Hours Spent Studying

Suppose you want to estimate the average number of hours that students in our school spend studying each week. Which of the following is the best method of sampling?

- a. Go to the library and ask all the students there how much they study.
- b. Email all students asking how much they study, and use all the data you get.
- c. Choose a sample of friends that resembles the general population of students at our school.
- d. Anonymously survey each student in our class. Require all students to respond.
- e. Stop people at random walking in the halls between classes and ask how much time they spend studying.

Task #3: School Advisory Panel

From a class containing 12 girls and 10 boys, three students are to be selected to serve on a school advisory panel. Here are four different methods of making the selection.

- I. Select the first three names on the class roll.
- II. Select the first three students who volunteer.
- III. Place the names of the 22 students in a hat, mix them thoroughly, and select three names from the mix.
- IV. Select the first three students who show up for class tomorrow.

Which is the best sampling method, among these four, if you want the school panel to represent a fair and representative view of the opinions of your class? Explain the weaknesses of the three you did not select as the best.

(Source: Illustrative Mathematics)

Independent Practice: Biased?

Indicate whether we should trust the results of the study. If the method of data collection is biased explain why.

- 1. Take 20 packages off the top of the load of packages being shipped by a truck and measure the amount of damage expected to the whole truckload.

- 2. A newspaper is curious about the satisfaction of their readers. When a person visits the newspaper’s webpage, they are asked to complete a brief summary online.

Correlation or Causation?

Decide whether each of the statement implies causation or simply association without causation. Identify whether each of the variables in the statement is a categorical or quantitative variable. Identify which variable is the explanatory and which is the response variable. Be sure to base your decision on the wording of the statement, not on your beliefs.

1. If you study more, your grades will improve.

2. Aging of the brain tends to be delayed in people with a college education.

3. Car owners tend to live longer than people who do not own a car.

4. A bad weather forecast leads to less students walking to school.

5. Seatbelts reduce the risk of a severe injury in a car accident.

Task #4: High Blood Pressure

In a study of college freshmen, researchers found that students who watched TV for an hour or more on weeknights were significantly more likely to have high blood pressure, compared to those students who watched less than an hour of TV on weeknights. Does this mean that watching more TV raises one’s blood pressure? Explain your reasoning.

(Source: Illustrative Mathematics)

Task #7: Strict Parents

Students in a high school mathematics class decided that their term project would be a study of the strictness of the parents or guardians of students in the school. Their goal was to estimate the proportion of students in the school who thought of their parents or guardians as “strict”. They do not have time to interview all 1,000 students in the school, so they plan to obtain data from a sample of students.

a. Describe the parameter of interest and a statistic the students could use to estimate the parameter.

b. Is the best design for this study a sample survey, an experiment, or an observational study? Explain your reasoning.

c. The students quickly realized that, as there is no definition of “strict,” they could not simply ask a student, “Are your parents or guardians strict?” Write three questions that could provide objective data related to strictness.

d. Describe an appropriate method for obtaining a sample of 100 students, based on your answer in part (a) above.

(Source: Illustrative Mathematics)

Task #8: Words and Music

A student interested in comparing the effect of different types of music on short-term memory conducted the following study: 80 volunteers were randomly assigned to one of two groups. The first group was given five minutes to memorize a list of words while listening to rap music. The second group was given the same task while listening to classical music. The number of words correctly recalled by each individual was then measured, and the results for the two groups were compared.

a. Is this an experiment or an observational study? Justify your answer.

b. In the context of this study, explain why it is important that the subjects were randomly assigned to the two experimental groups (rap music and classical music).

(Source: Illustrative Mathematics)

Left or Right Handed? Mac or PC?

Display the data in a two-way table such as the one below.

	Left	Right	Total
Mac	2	8	10
PC	1	14	15
	3	22	25

1. What proportion of students is left-handed? Right-handed?

2. What proportion of students use a Mac? A PC?

3. What proportion of students is left-handed and use a Mac?

4. What proportion of Mac users is right-handed?

5. What proportion of Mac users is left-handed?

6. What proportion of right-handed students use a Mac?

7. What proportion of left-handed students use a Mac?

8. If we want to determine whether left-handed people are more likely to use a Mac than right-handed people, which pair of proportions is more relevant to consider, the proportions in questions four and five or the proportions in six and seven? Why?

9. Do you think the difference is significant?

(Source: Illustrative Mathematics)

Task #9: Titanic Survivors

On April 15, 1912, the Titanic sank after tragically striking an iceberg. The two-way table below breaks down the likelihood of survival by class of passenger.

	Survived	Did Not Survive	Total
1st Class	203	122	325
2nd Class	118	167	285
3rd Class	178	528	706
Crew	212	673	885
Total	711	1490	2201

Discuss whether the following statement is accurate. If so, use proportions from the table above to support the statement. If the statement is not accurate, explain why?

“Since more crew survived (212) than any other class, the crew were more likely to survive the sinking than any class of passenger.”

Task #10: Vaccine Recipients

In a study of 500 children from a city, 238 were randomly selected to receive a new vaccine. The other 262 children were randomly selected to receive a placebo. The children and the physicians did not know to which group they have been assigned. After five years, 22 of the 238 children who received the vaccine had been infected with malaria; while 28 out of the 262 children who received the placebo had been infected with malaria.

a. Is this an experiment or an observational study?

b. What are the variables? Which are categorical/quantitative? Explanatory/response?

c. Using the information above, set up a two-way table to determine whether the vaccine is effective.

d. Use your two-way table to determine whether the vaccine is effective or not.

e. Do you believe the vaccine is effective?

Task #11: Musical Preferences

The 54 students in one of several middle school classrooms were asked two questions about musical preferences: “Do you like rock?” “Do you like rap?” The responses are summarized in the table below.

	Likes Rap	Doesn't Like Rap	Total
Likes Rock	27	6	33
Doesn't Like Rock	4	17	21
Total	31	23	54

a. Is this a random sample, one that fairly represents the opinions of all students in the middle school?

b. What percentage of the students in the classroom like rock?

c. Is there evidence in this sample of an association in this class between liking rock and liking rap? Justify your answer by pointing out a feature of the table that supports it.

d. Explain why the results for this classroom might not generalize to the entire middle school.

(Source: Illustrative Mathematics)

Task #12: High Temperatures

The high temperature for each day in 2013 is displayed for three different cities on each of the three histograms below.

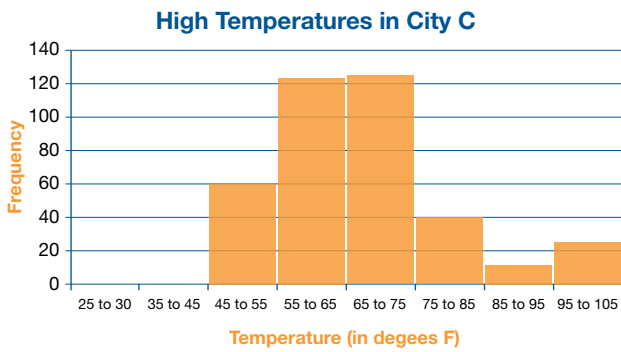
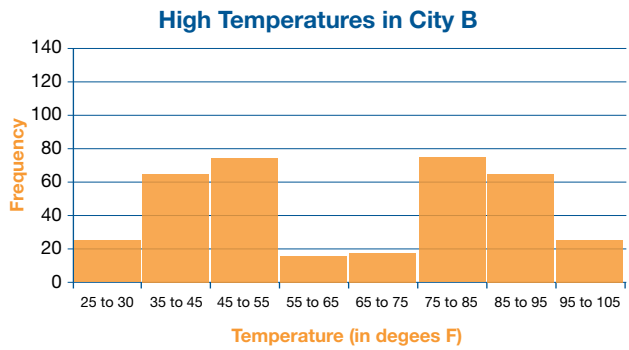
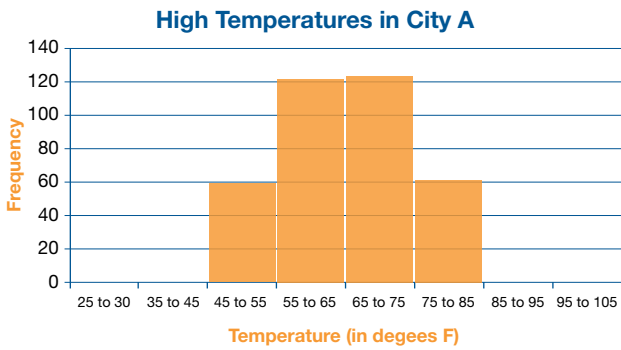

1. How many values are being displayed in each histogram?

2. Explain in this context what it means that city A has a histogram where the height of the bar over the range 45 to 55 is 60?

3. Which city had the most days with a high less than 32 degrees F? _____

4. Which city had the most days over 90 degrees F? _____

5. Approximate the median in each of three graphs. Explain how you determined your answer.

6. If the three graphs represent the high temperature for all 365 days in 2013 in three different cities, write a sentence summarizing the weather of each city in 2013. Which city would you prefer to live in?

7. Which city had the greatest mean high temperature in 2013? How did you determine your answer?

8. Which city has the smallest mean?

Task #13: Insuring a Car

The histogram below shows the distribution in the values of the average cost of insuring a car in each of the fifty states and the District of Columbia.

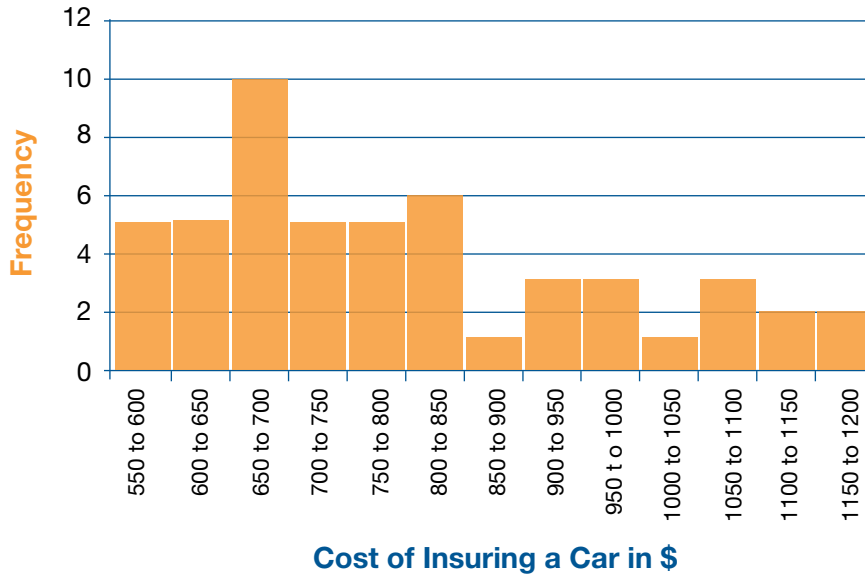

Approximate the median of this distribution. Round your answer to one decimal place and use the appropriate notation when expressing your answer.

Will the mean cost of insuring a car be more or less than the median? How can you tell?

(data found at <http://www.census.gov/hhes/www/hlthins/data/historical/index.html>)

Task #14: Which has a Greater Standard Deviation?

Which do you expect to have a greater standard deviation: the distribution of the number of siblings of all students in our class or the distribution of the number of Facebook friends of all students in our class? Explain how you determined your answer.

Task #15: The Shape and Center of Data: Quiz Scores

A college statistics professor gave the same quiz (scored out of a total of 10 points) to his students over the past seven years. The distribution of the scores are displayed in the histograms labeled (i)-(vi) below.

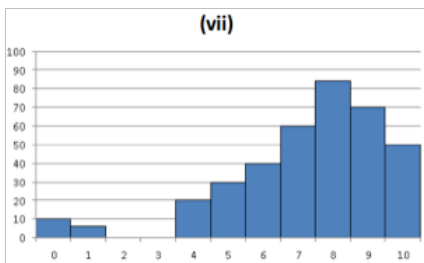
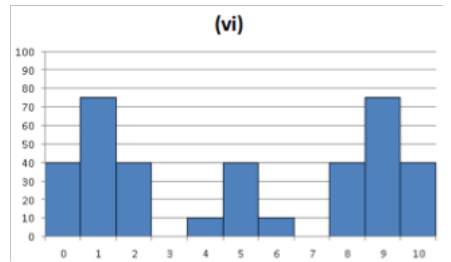
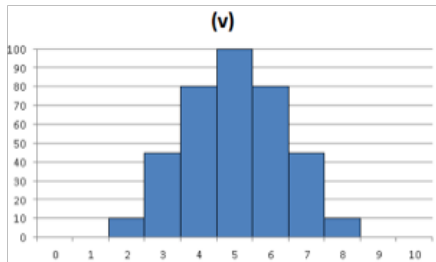
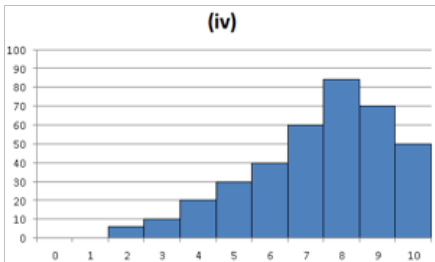
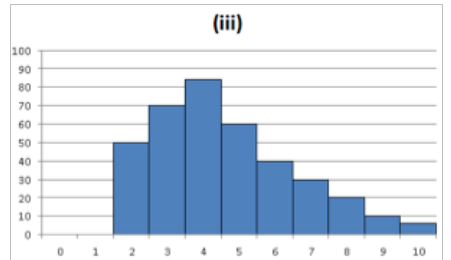
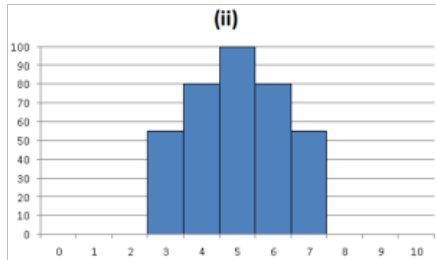
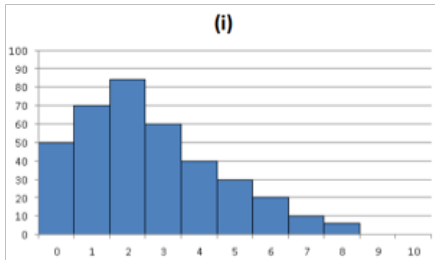

1. Which histogram(s) have a mean which is greater than its median? What does this imply about the distribution of the students' scores?

2. Which histogram(s) have a mean which is equal to its median? What does this imply about the distribution of the students' scores?

3. Which histogram appears to have the smallest mean? Interpret what this means in the context of quiz performance.

4. Which histogram appears to have the largest mean? Interpret what this means in the context of quiz performance.

5. Which histogram appears to have the largest standard deviation? Interpret what this means in the context of quiz performance.

6. Which histogram appears to have the smallest standard deviation? Interpret what this means in the context of quiz performance.

Task #16: Investigating Correlations with Cars Data

The Consumer Reports 1999 New Car Buying Guide contains lots of information for a large number of new (at that time) car models. Some of the data for 109 of these cars has been extracted. This activity will focus on the relationships among several of these variables including:

- Weight** = Weight of the car (in pounds)
- CityMPG** = EPA’s estimated miles per gallon for city driving
- FuelCap** = Size of the gas tank (in gallons)
- QtrMile** = Time (in seconds) to go 1/4 mile from a standing start
- Acc060** = Time (in seconds) to accelerate from zero to 60 mph
- PageNum** = Page number on which the car appears in the buying guide

1. Initial guesses (BEFORE looking at the data)

Consider the relationship you would expect to see between each the following pairs of variables for the car data. Place the letter for each pair on the chart below to indicate your guess as to the direction (negative, neutral or positive) and strength of the association between the two variables. *Note: You may have more than one letter at approximately the same spot.*

- (a) Weight vs. CityMPG
- (b) Weight vs. FuelCap
- (c) PageNum vs. FuelCap
- (d) Weight vs. QtrMile
- (e) Acc060 vs. QtrMile
- (f) CityMPG vs. QtrMile

Strong	Moderate	Weak	No	Weak	Moderate	Strong
Negative	Negative	Negative	Association	Positive	Positive	Positive
←—————→						

2. Associations from scatterplots

- Examine scatterplots for the various pairs of car variables listed above.
- Revise your estimates on the direction and strength of each association in the chart below.

Strong	Moderate	Weak	No	Weak	Moderate	Strong
Negative	Negative	Negative	Association	Positive	Positive	Positive
←—————→						

- How did you do with your initial guesses?

3. Correlations for each pair

The correlation coefficient, denoted by r , is a measure of the strength of the linear association between two variables. Use the values shown in the slides to record the correlation for each of the six pairs of variables, (a) – (f).

	correlation		correlation
(a) Weight vs. CityMPG		(d) Weight vs. QtrMile	
(b) Weight vs. FuelCap		(e) Acc060 vs. QtrMile	
(c) PageNum vs. FuelCap		(f) CityMPG vs. QtrMile	

4. Properties of correlation

Based on your observations of the scatterplots and computed correlations, write down at least three properties that would appear to be true about a sample correlation and its interpretation.

(1)

(2)

(3)

Task #17: Academic Achievement

Medhavi suspects that there is a relationship between the number of text messages high school students send and their academic achievement. To explore this, she asks each student in a random sample of 52 students from her school how many text messages he or she sent yesterday and what his or her grade point average (GPA) was during the most recent marking period. The data are summarized in the scatter plot of number of text messages sent versus GPA, shown below.

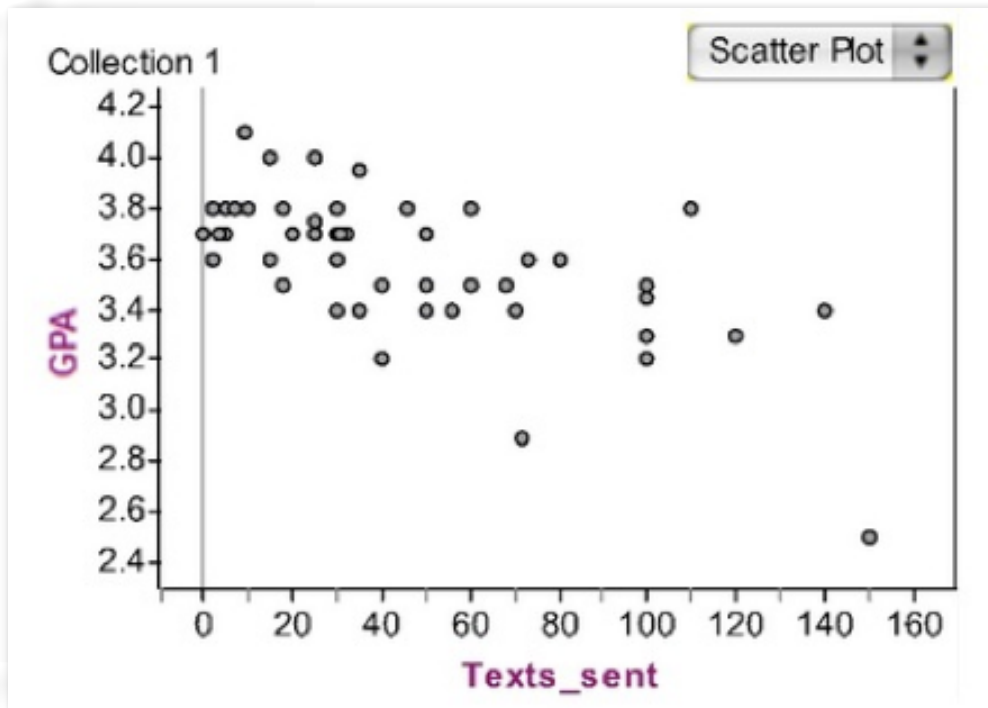

Describe the relationship between number of text messages sent and GPA. Discuss both the overall pattern and any deviations from the pattern.

(Source: Illustrative Mathematics)

Task #17: Academic Achievement #2

Medhavi suspects that there is a relationship between the number of text messages high school students send and their academic achievement. To explore this, she asks a random sample of 52 students at her school how many text messages they sent yesterday and what their grade point average (GPA) was during the most recent marking period. Her data are summarized in the scatter plot below. The least squares regression line is also shown.

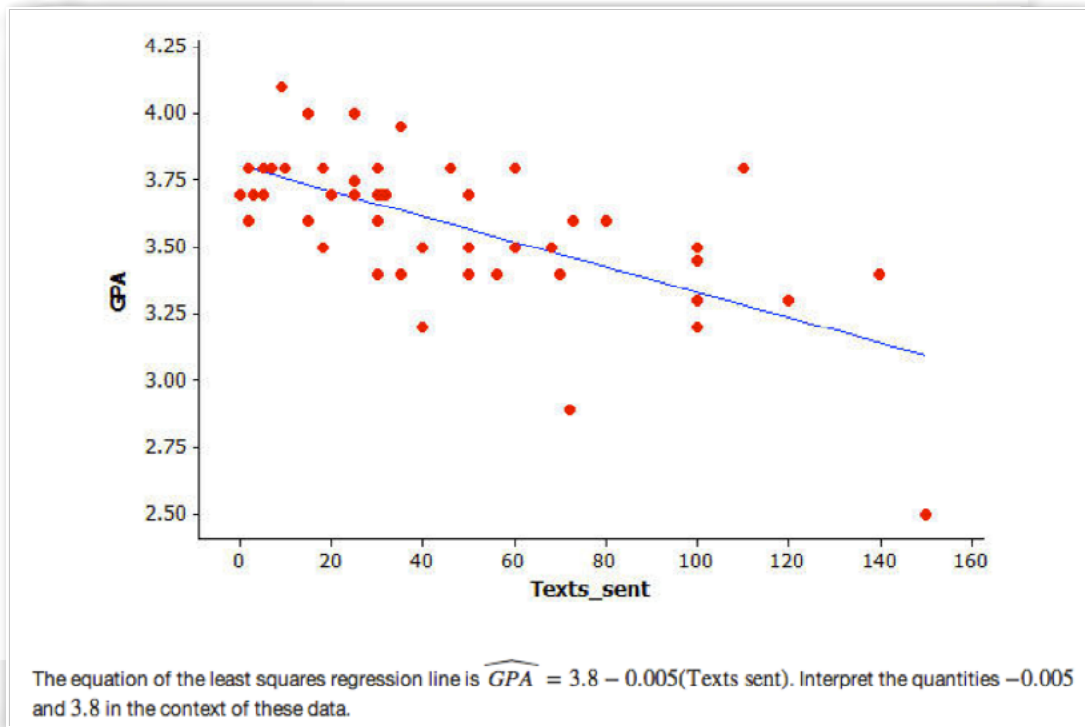

(Source: Illustrative Mathematics)

A Show of Hands/Arm in Arm

Name	Finger to Finger	Finger to Wrist	Wrist to Elbow

FF	FW

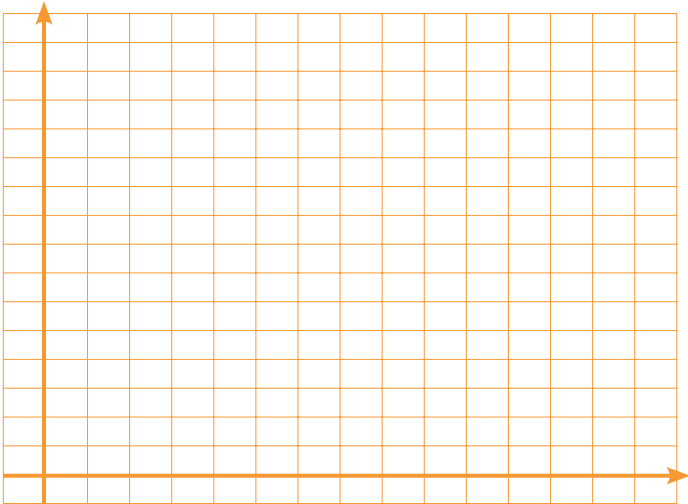

r =

A Show of Hands/Arm in Arm

FF	FW

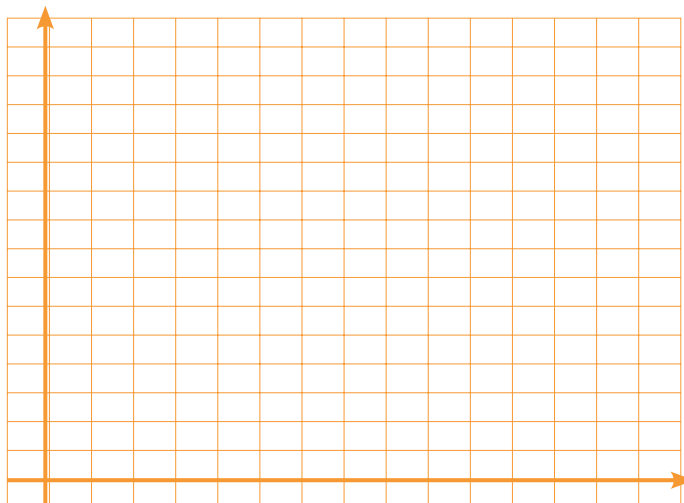

r =

FF	FW

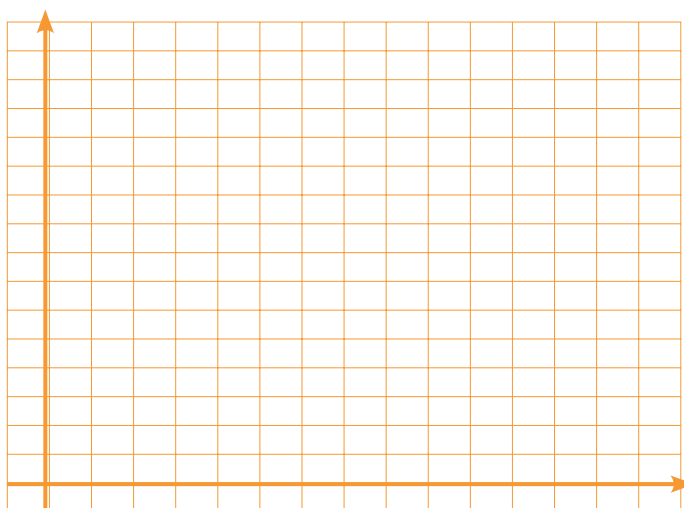

r =

Task #18: Academic Achievement #3

Medhavi suspects that there is a relationship between the number of text messages high school students send and their academic achievement. To explore this, she asks a random sample of 52 students at her school how many text messages they sent yesterday and what their grade point average (GPA) was during the most recent marking period. Her data are summarized in the scatter plot below. The least squares regression line is also shown.

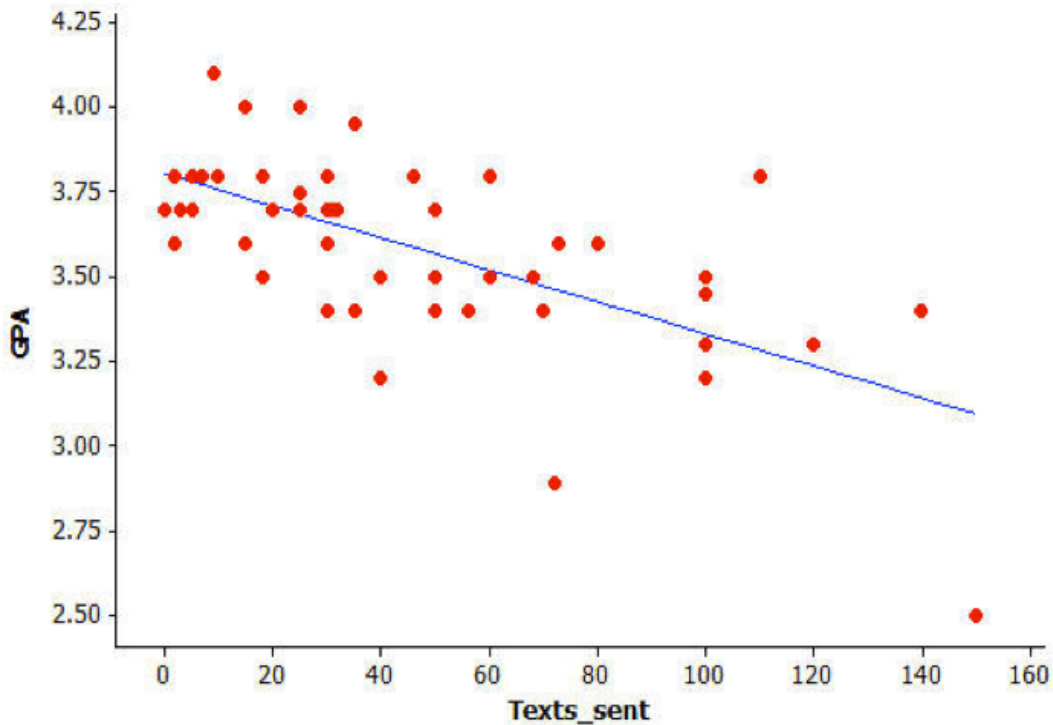

The equation of the least squares regression line is $\widehat{GPA} = 3.8 - 0.005(\text{Texts sent})$. Interpret the quantities -0.005 and 3.8 in the context of these data.

(Source: Illustrative Mathematics)

Task #19: Olympic Gold Medalist

The scatterplot below shows the finishing times for the Olympic gold medalist in the men’s 100-meter dash for many previous Olympic games. The least squares regression line is also shown. (Source: <http://trackandfield.about.com/od/sprintsandrelays/qt/olymp100medals.htm>.)

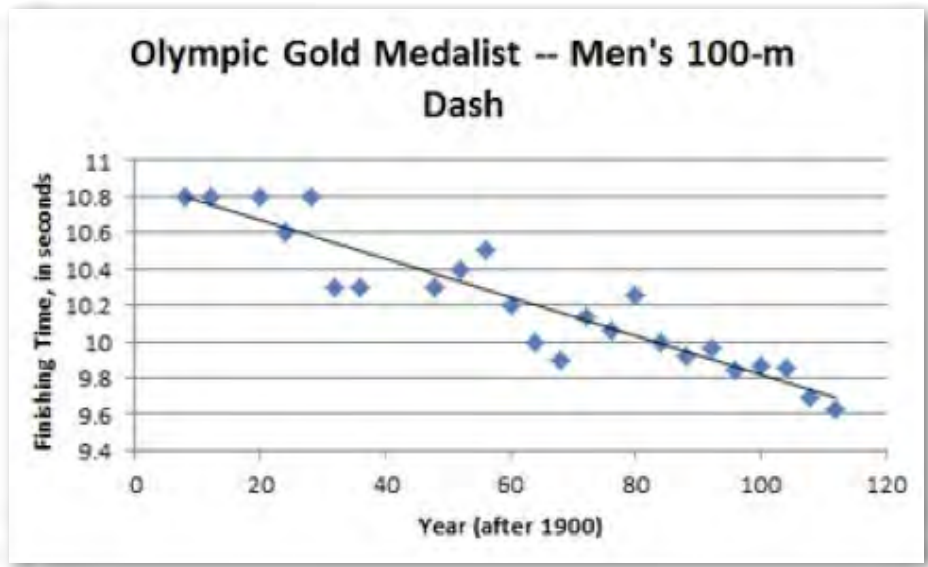

a. Is a linear model a good fit for the data? Explain, commenting on the strength and direction of the association.

b. The equation of the linear function that best fits the data (regression line) is $\hat{y} = 10.878 - 0.0106(\text{Year after 1900})$. Given that the summer Olympic games only take place every four years, how should we expect the gold medalist’s finishing time to change from one Olympic games to the next?

c. What is the vertical intercept of the function's graph? What does it mean in context of the 100-meter dash?

d. Note that the gold medalist finishing time for the 1940 Olympic games is not included in the scatterplot. Use the model to estimate the gold medalist's finishing time for that year.

e. What is a realistic domain for the linear regression function? Comment on how your answer pertains to using this function to make predictions about future Olympic 100-m dash race times.

Source: Illustrative Mathematics